

STORM DRAINAGE REPORT

For:

Headrick Residence

8822 SE 62nd Street

Mercer Island, WA 98040

Owner:

Greg Headrick

8822 SE 62nd Street

Mercer Island, WA 98040

Engineer:

Bush, Roed and Hitchings

Ted Dimof, PE

Bush, Roed and Hitchings

2009 Minor Avenue E

Seattle, WA 98102

(206) 323-4144

BRH Project: 2019094



Date: May 23, 2023

Table of Contents

1.0 - PROJECT OVERVIEW	1
2.0 – MINIMUM REQUIREMENTS	2
3.0 – SITE ANALYSIS.....	4
3.1 - Phased Offsite Analysis.....	4
3.2 - Downstream Analysis	4
3.4 - Critical Areas and Flood Plain	5
4.0 – PERMANENT STORMWATER CONTROL	6
4.1 - Low Impact Development and Flow Control.....	6
List #2: On-Site SW BMPs for project triggering MR 1-9:	6
4.2 - Low Impact Development Design.....	8
4.3 - Water Quality.....	10
4.4 - Source Control.....	10
4.5 - Conveyance System Analysis and Design	10
5.0 – SPECIAL REPORTS AND STUDIES.....	11
6.0 – OTHER PERMITS	11
7.0 – CONSTRUCTION STORMWATER POLLUTION PREVENTION (MR-2)	12
9.0 – APPENDICES	16
Appendix A – Onsite Basin Maps.....	16
Appendix B – Onsite Plans	17
Appendix C – Geotechnical Report.....	18
Appendix D – Reconnaissance Report	19

List of Figures

Figure 1	Vicinity Map	1
Figure 2	Downstream Flow Path.....	4

1.0 - PROJECT OVERVIEW

The site is located at 8822 SE 62nd Street and consists of one garage and a one-story building on parcel, #8650500040, with an area of 27,481 square feet (0.631 acres).

The Headrick Residence project proposes to demolish the existing residence and swimming pool and some pavement onsite to add a new garage and residential structure, extend the driveway, and build a new swimming pool with a pervious wood deck.

The existing site is partially developed with roof, and asphalt parking area. The undeveloped portion of the site is made up of trees and dense brush. The site generally has flat to moderate slopes. The existing driveway slopes moderately towards the existing garage. Around the building, the site is fairly flat with slopes ranging from 1-3%. The landscape on the east side of the property slopes east towards the east at an approximate slope of 25%. A steep slope is located at the edge of the site and a small drainage course drains at the base of the slope. See **Appendix D for the Reconnaissance Report.**

The sites' existing contours were preserved wherever possible. New catch basins were proposed to capture runoff from the pavement and the roof. These onsite new structures will tie back into the existing system, preserving the overall function of the existing system.

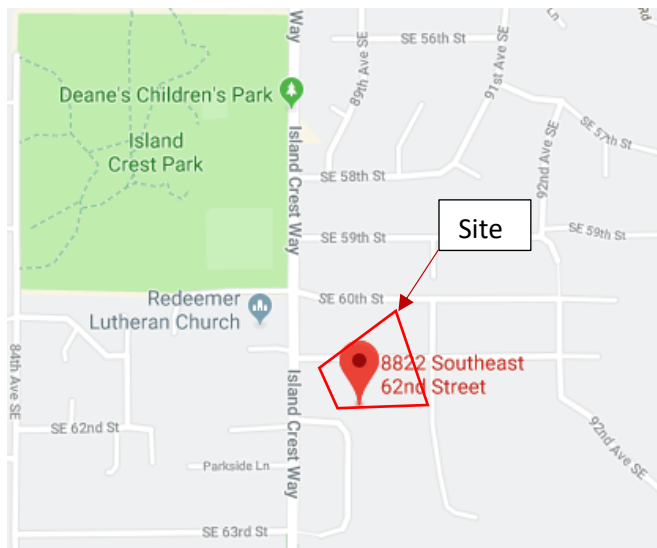

Figure 1 – Vicinity Map

2.0 – MINIMUM REQUIREMENTS

The design of the facilities on site conforms to the “2014 Stormwater Management Manual for Western Washington” and “City Of Mercer Island On-Site Detention Design Requirements”.

Minimum Requirements Analysis

In order to establish the minimum requirements for this project, the “City Of Mercer Island Stormwater Management Standards” guidance sheet was used. The site installs more than 5,000 square feet of new plus replaced impervious surface (10,781 sf). Minimum #1 through #9 apply to this project.

1. Preparation of Stormwater Site Plans:

A storm water site plan has been prepared and has been submitted for review and acceptance.

2. Construction Stormwater Pollution Prevention Plan:

A CSWPP Plan has been prepared and is included as section 7 of this report in accordance with the ECY Manual.

3. Source Control of Pollution:

There will be no outdoor storage of fertilizers, pesticides, equipment or materials that will allow pollutants to enter the stormwater system.

4. Preservation of Natural Drainage Systems and Outfalls:

The site does not have existing drainage structures. Stormwater sheet flows to the east and goes to a ditch. The ditch carries the flow south for 115 ft where water flows south to an 18 inch storm main for 586 feet and discharges to a creek before reaching Lake Washington.

The proposed drainage will implement catch basins and roof leaders to drain runoffs to the proposed bioretention planters. The bioretention planters will be piped to a flow spreader that eventually discharges to the existing water course.

The proposed drainage eventually meets the existing drainage thus preserving drainage patterns.

5. On-Site Stormwater Management:

The 2,000 SF impervious surface threshold has been exceeded, and On-Site Stormwater Management will be required. List #2 was applied to all replaced and new hard surfaces on-site. All impervious surfaces were mitigated by bioretention planters. See **Section 4.2 – Low Impact Development design**.

6. Runoff Treatment:

The site will install less than 5,000 sf of PGHS (2,722 sf); therefore, water quality is not required.

7. Flow Control:

Although the project creates more than 2,000 sf of new and replaced hard surfaces (10,781 sf), per the City of Mercer Island's stormwater management standards, Flow Control (MR-7) is not required for projects that any of the BMPs included on List #1 and List #2 are determined feasible for impervious and pervious surfaces. Since the project proposes to mitigate all of the hard surfaces with bioretention planters, additional flow control is not required.

8. Wetlands Protection:

There are no wetlands on the subject property or in the immediate vicinity of the site; therefore no protection measures are necessary.

9. Basin/Watershed Planning:

No basin or watershed planning requirements apply to this site.

3.0 – SITE ANALYSIS

3.1 - Offsite Analysis

Volume 1, Section 3.1.3 of the ECY Manual recommends that projects adding 5,000 sf of *new* hard surface should conduct an Off-Site Analysis (downstream analysis). The project does meet that threshold.

3.2 - Downstream Analysis

A downstream analysis was conducted. See **Figure 2** below for the downstream flow path.

The entire site is within Lake Washington drainage basin. Onsite stormwater drains to a watercourse that drains into an existing 18in storm main.

The site does not have existing drainage structures; therefore, runoffs sheet flow to the east where a slope is located at the edge of the site and a small drainage course drains at the base of the slope.

Per records, the small water course carries the flow south for 115 ft where water enters an 18 inch storm main for 586 feet and discharges to a creek that carries the flows for 0.6 miles before discharging Lake Washington.

The proposed drainage will implement catch basins and roof leaders to drain runoffs to the proposed bioretention planters. The bioretention planters will be piped to the inlet of the 18 inch main and a new manhole will be placed at the entry of that inlet to convey flow from the site and the existing drainage.

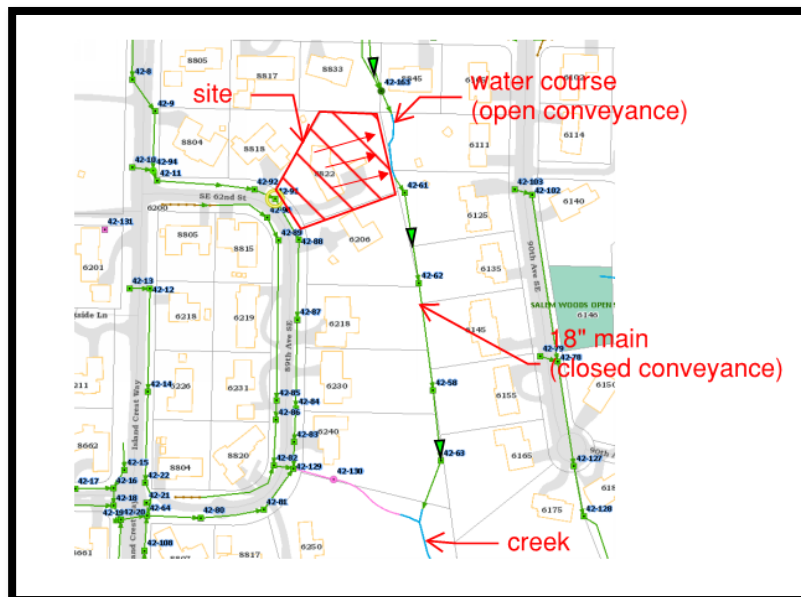

Figure 2 – Downstream flow path

3.3 - Soils/Infiltration Rates

During the geotechnical investigation, three test pits and two test holes were performed. The results of those borings revealed 2 - 4 inches of topsoil loose fill encountered. Underlying topsoil, native soils were encountered consisting primarily of gravelly silty sand but became dense of about 5 feet deep in two of the test pits. Perched groundwater was encountered at depths of 4 feet in one of the five explorations. See the **Geotechnical Report** in **Appendix C** for more detail.

3.4 - Critical Areas and Flood Plain

There is a seasonal water course at the edge of the property. Water course and Buffer zones were delineated and are shown on the topographic survey and the critical area report. See **Appendix D** for **Reconnaissance Report**.

4.0 – PERMANENT STORMWATER CONTROL

4.1 - Low Impact Development and Flow Control

Although the project creates more than 2,000 sf of new and replaced hard surfaces (10,781 sf), per the City of Mercer Island's stormwater management standards, Flow Control (MR-7) is not required for projects that any of the BMPs included on List #1 and List #2 are determined feasible for impervious and pervious surfaces. See **Section 2.0** for a description of the minimum requirements, **Section 4.2** for Low Impact Development Design and **Appendix A – Onsite Basin Map** for hard surface summary and sub-basins location.

Low Impact Development (Stormwater BMPs) are required per MR-5. The purpose of MR-5 is to design the site to retain as much stormwater on site as possible through the use of the various BMPs described in the Chapter 5 of Volume V of the DOE Manual. **City of Mercer Island Infeasibility List Handout** has been used to determine BMP feasibility for each new and replaced hard surface.

List #2: On-Site SW BMPs for project triggering MR 1-9:

Landscaped Areas:

All landscaping is proposed to have amended soils per BMP T5.13: Post Construction Soil Quality and Depth.

Roofs:

Sub-basin I Roof:

1. Full Dispersion is infeasible due to the lack of vegetated flow path from the surface. The eastern portion of the site provides about 52 lf of native vegetated flow path; however, the required flow path length is 100 lf. Thus, full dispersion for the sub-basin I roof is infeasible. See **Appendix A – Basin Map** for flow path exhibit and hard surface summary.
2. Downspout Full Infiltration is infeasible because there is no out-wash or loam soils present onsite. Per the Geotechnical Report, Glacial Till soil were encountered during boring exploration in all the borings. Thus limiting full infiltration onsite. See **Appendix C - Geotechnical Report** page 3 for more details.
3. A Bioretention planter with a closed bottom is feasible and proposed onsite. The site does not contain critical areas, drinking water wells or any sewage disposal system. In addition, the slopes around the building vary from 2 – 10% and the proposed bioretention planter will be placed on flat grades. Thus, satisfying site suitability criteria. The impervious area draining to bioretention planter A is 6,288 sf (Sub-basins I & V and the patio pavers) which does not exceed 5,000 sf of PGHS, 10,000 sf of impervious area, and 0.75 acres of lawn. Thus, making bioretention feasible. See **Appendix A – Basin Map** for hard surface summary.

Sub-basin II Roof:

1. Full Dispersion is infeasible due to the lack of vegetated flow path from the surface. The northern portion of the site provides about 78 lf of native vegetated flow path; however, the required flow path length is 100 lf. Thus, full dispersion for the sub-basin II roof is infeasible. See **Appendix A – Basin Map** for flow path exhibit and hard surface summary.
2. Downspout Full Infiltration is infeasible because there is no out-wash or loam soils present onsite. Per the Geotechnical Report, Glacial Till soil were encountered during boring exploration in all the borings. Thus limiting full infiltration onsite. See **Appendix C - Geotechnical Report** page 3 for more details.
3. A Bioretention planter with a closed bottom is feasible and proposed onsite. The site does not contain critical areas, drinking water wells or any sewage disposal system. In addition, the slopes around the building vary from 2 – 10% and the proposed bioretention planter will be placed on flat grades. Thus, satisfying site suitability criteria. The impervious areas draining to bioretention planter B is 1,829 sf which does not exceed 5,000 sf of PGHS, 10,000 sf of impervious area, and 0.75 acres of lawn. Thus, making bioretention feasible. See **Appendix A – Basin Map** for hard surface summary.

Sub-basin III Roof:

1. Full Dispersion is infeasible due to the lack of vegetated flow path from the surface. The northern portion of the site provides about 78 lf of native vegetated flow path; however, the required flow path length is 100 lf. Thus, full dispersion for the sub-basin II roof is infeasible. See **Appendix A – Basin Map** for flow path exhibit and hard surface summary.
2. Downspout Full Infiltration is infeasible because there is no out-wash or loam soils present onsite. Per the Geotechnical Report, Glacial Till soil were encountered during boring exploration in all the borings. Thus limiting full infiltration onsite. See **Appendix C - Geotechnical Report** page 3 for more details.
3. A Bioretention planter with a closed bottom is feasible and proposed onsite. The site does not contain critical areas, drinking water wells or any sewage disposal system. In addition, the slopes around the building vary from 2 – 10% and the proposed bioretention planter will be placed on flat grades. Thus, satisfying site suitability criteria. The impervious areas draining to bioretention planter C is 451 sf which does not exceed 5,000 sf of PGHS, 10,000 sf of impervious area, and 0.75 acres of lawn. Thus, making bioretention feasible. See **Appendix A – Basin Map** for hard surface summary.

Sub-basin IV Roof:

1. Full Dispersion is infeasible due to the lack of vegetated flow path from the surface. The topography from the area of the surface does not positively drain away from the building. Thus, full dispersion for the sub-basin II roof is infeasible. See **Appendix A – Basin Map** for flow path exhibit and hard surface summary.

May 23, 2023

2. Downspout Full Infiltration is infeasible because there is no out-wash or loam soils present onsite. Per the Geotechnical Report, Glacial Till soil were encountered during boring exploration in all the borings. Thus limiting full infiltration onsite. See **Appendix C - Geotechnical Report** page 3 for more details.
3. A Bioretention planter with a closed bottom is feasible and proposed onsite. The site does not contain critical areas, drinking water wells or any sewage disposal system. In addition, the slopes around the building vary from 2 – 10% and the proposed bioretention planter will be placed on flat grades. Thus, satisfying site suitability criteria. The impervious areas draining to bioretention planter D is 1,529 sf which does not exceed 5,000 sf of PGHS, 10,000 sf of impervious area, and 0.75 acres of lawn. Thus, making bioretention feasible. See **Appendix A – Basin Map** for hard surface summary.

Other Hard Surfaces:

Sub-Basin I Driveway Pavement (PGIS) and Concrete Sidewalk/Patio:

1. Full Dispersion is infeasible due to the lack of vegetated flow path from the surface. The eastern portion of the site provides about 46 lf of native vegetated flow path; however, the required native vegetated flow path length is 100 lf. Thus, full dispersion for the roof in Sub-basin I is infeasible. See **Appendix A - figure 2** for flow path exhibit.
2. Permeable Pavement is infeasible. The eastern portion of the site contains slopes greater than 20 percent. The Driveway and the sidewalk are located within 50 feet from the top of slopes exceeding 20 percent. Thus, permeable pavement is infeasible.
3. Bioretention planters with closed bottoms are feasible and proposed onsite. The site does not contain critical areas, drinking water wells or any sewage disposal system. Although the slopes on the eastern portion of the site varies from 2 – 40% the vertical relief from the top of the slope does not exceed 10 feet (8 feet to 9 feet). In addition, the proposed bioretention planters will be placed on flat grades. Thus, satisfying site suitability criteria. The impervious area draining to bioretention planter A is 6,288 sf (Sub-basins I & V and the patio pavers) which does not exceed 5,000 sf of PGHS, 10,000 sf of impervious area, and 0.75 acres of lawn. Thus, making bioretention feasible. See **Appendix A – Onsite Basin Map** for hard surface summary.

4.2 - Low Impact Development Design

Non-infiltrating bioretention planters were used where feasible to mitigate as much of the site as possible. There are three non-infiltrating bio-retention planters receiving all new and replaced hard surface of the total impervious surfaces. See **Appendix A** for onsite basin map and **Appendix B** for Onsite Plans.

Sub-Basin I represents the part of the roof draining to **Bioretention planter A** (2,657 sf).

Sub-Basin II represents part of the roof draining to **Bioretention planter B** (1,829 sf).

Sub-Basin III represents part of the roof draining to **Bioretention planter C** (451 sf).

Sub-Basin IV represents part of the roof draining to **Bioretention planter D** (1,529 sf).

Sub-Basin V represents the impervious pavement surface to **Bioretention planter A** (3,457sf).

The patio pavers represents a portion of impervious pavement surface to **Bioretention planter A** (174 sf).

Design Criteria for Bioretention:

1. *Flow Entrance and Presettling:*

Riprap rocks will be placed at the entrance of the pipes to minimize erosion potential. This will apply for all the proposed bioretention planters.

2. *Bottom Area*

The bottom width of the bioretention planters should not be less than two feet.

The width of Bioretention planter A varies from approximately 5 feet to approximately 10 feet.

The width of Bioretention planter B is 7 feet.

The width of Bioretention planter C is a minimum of 2 feet.

The width of Bioretention planter D is approximately 6 feet.

3. *Ponding Area*

The minimum required surface area corresponds to 5% of the total impervious surface and 2% of lawn draining to it.

Bioretention Planter A receives 2,657 sf of impervious surface from Basin I, 3,457 sf from Basin IV and 174 sf from the patio pavers. Therefore, the minimum surface area of **Bioretention Planter A** is:

$$((2,657\text{sf} + 3,457\text{sf} + 174\text{sf}) \times 5)/100 = 314.4 \text{ sf.}$$

The project proposes a 326 sf bioretention planter which satisfies the surface minimum requirement with additional capacity.

Bioretention Planter B receives 1,829 sf of impervious surface from Basin II. Therefore, the minimum surface area of **Bioretention Planter B** is:

$$(1,829 \text{ sf} \times 5)/100 = 91.5 \text{ sf.}$$

The project proposes a 140 sf bioretention planter which satisfies the surface minimum requirement with additional capacity.

Bioretention Planter C receives 451 sf of impervious surface from Basin III. Therefore, the minimum surface area of **Bioretention Planter C** is:

$$(451\text{sf} \times 5)/100 = 22.6 \text{ sf.}$$

The project proposes a 39.75 sf bioretention planter which satisfies the surface minimum requirement with additional capacity.

Bioretention Planter D receives 1,529 sf of impervious surface from Basin IV. Therefore, the minimum surface area of **Bioretention Planter D** is:

$$(1,529 \text{ sf} \times 5)/100 = 76.5 \text{ sf.}$$

The project proposes a 79.15 sf bioretention planter which satisfies the surface minimum requirement with additional capacity.

4. *Ponding Depth*

The ponding depth recommendation for each bioretention planter is 6 in. WWHM was used to make sure all the draining water is getting filtered through the bioretention planter without overflowing. See **Appendix E** WWHM Calculations for Bioretention Planters.

5. *Surface Overflow*

Vertical stand pipes that are connected to underdrains represent the overflow for each bioretention planter. See **Appendix B – Onsite Plans** for the location of the overflows.

6. *Default Bioretention Soil Media (BSM)*

The proposed bioretention planters will use the BSM; therefore, testing the media for its saturated hydraulic conductivity is not required. Mineral Aggregate Gradation is found in **Table V-7.4.1** of “2019 Stormwater Management Manual for Western Washington”. Compost standards to ensure healthy growth support is also found in **Chapter V-7 – Infiltration and Bioretention Treatment Facilities** of “2012 Stormwater Management Manual for Western Washington”.

7. *Soil Depth and Mulch Layer*

The soil depth of all bioretention planter is 18 in. The mulch layer is a 3 in coarse compost in the bottom of the facilities. See **Appendix B** for **Bioretention Planter Typical Cross Section**.

8. *Underdrain*

There will be a 4 in slotted underdrain PVC pipe per ASTM D1785 SCH 40. The slotted Underdrain is surrounded of underdrain aggregate material. See **Appendix B** for a **typical bioretention planter cross section**. The guidance for the aggregate underdrain filter and bedding layer is found in **Chapter V-7 – Infiltration and Bioretention Treatment Facilities** of “2019 Stormwater Management Manual for Western Washington”.

9. *Plant Material*

Plant material utilized in bioretention areas are facultative species adapted to stresses associated with wet and dry conditions. Red alder or Clustered wild rose can be used as plant materials. See **the LID Technical Guidance Manual for Puget Sound (2012)** for additional guidance and other recommended plant species.

4.3 - Water Quality

N/A – See Section 2.0 for minimum requirements overview.

4.4 - Source Control

N/A

4.5 - Conveyance System Analysis and Design

A Conveyance System Analysis and Design can be provided upon request.

5.0 – SPECIAL REPORTS AND STUDIES

The Geotechnical Engineering Report is **Appendix C** for this report. The Geotechnical Engineering Study was prepared by:

Engineer: Geotech Consultants, INC
Date: March 20, 2019

The Critical Areas Reconnaissance Report is **Appendix D** for this report. The Critical Areas Reconnaissance Study was prepared by:

Engineer: Wetland Resources, INC
Date: September, 2018

6.0 – OTHER PERMITS

N/A

7.0 – CONSTRUCTION STORMWATER POLLUTION PREVENTION (MR-2)

The CSWPPP was developed per the requirements in Chapter 24 of the Engineering Development Standards and Volume II of the 2014 Stormwater Management Manual for Western Washington.

13 Elements:

1. Preserve Vegetation/Mark Clearing Limits

Construction Limits will be marked by chain link fencing and/or high visibility fence where necessary (BMP C103), which will be moved as necessary for construction phasing of the various project elements.

2. Establish Construction Access

Entrance to the site will be off of the existing driveway as shown in the TESC plan. Trucks will be positioned to avoid exposed soil and excavation equipment will be washed on-site prior to transfer off-site, per BMP C106.

3. Control Flow Rates

Exposed soils are mostly limited to the area within the new foundation, which will contain sediment and runoff.

Wattles (BMP C235) and filter socks will be used as necessary to contain runoff to the construction area.

4. Install Sediment Controls

Perimeter protection will be provided in the form of silt fence (BMP C233), straw wattles (BMP C235) and/or compost socks.

5. Stabilize Soils

Exposed soils will be limited to the building foundation, utility trenching and pavement restoration. Landscaped surfaces will be given topsoil per BMP C125, and other exposed soils will be mitigated with plastic covering per BMP C123 as necessary. The entire site will apply dust control per BMP C140 during dry weather periods.

6. Protect Slopes

N/A – All cut and fill slopes will be designed, constructed, and protected in a manner that minimizes erosion.

7. Protect Drain Inlets

All catch basins on site and in the right-of-way within 500 ft downstream of the construction site will be protected with Storm Drain Inlet Protection per BMP C220 for the duration of the project.

8. Stabilize Channels and Outlets

N/A – No channels to protect.

May 23, 2023

9. Control Pollutants

Silt Fence as well as straw wattles and/or compost socks will be used to capture laden runoff. In addition, the equipment used will be in good working order.

10. Control Dewatering

Construction is relatively shallow and groundwater is not anticipated during construction. All trench and building excavation will be self-contained to prevent runoff. If groundwater is encountered, sump pumps will pump to either the sediment trap or sediment tanks prior to discharge.

11. Maintain BMPs

All temporary and permanent erosion and sediment control BMPs shall be maintained and repaired as needed to assure continued performance of their intended function. Maintenance and repair shall be conducted in accordance with each particular BMPs specifications.

Visual monitoring of the BMPs will be conducted at least once every calendar week and within 24 hours of any stormwater or non-stormwater discharge from the site. If the site becomes inactive, and is temporarily stabilized, the inspection frequency will be reduced to once every month.

All temporary erosion and sediment control BMPs shall be removed within 30 days after the final site stabilization is achieved or after the temporary BMPs are no longer needed. Trapped sediment shall be removed or stabilized on site. Disturbed soil resulting from removal of BMPs or vegetation shall be permanently stabilized.

12. Manage the Project

Erosion and sediment control BMPs for this project have been designed based on the following principles:

- Design the project to fit the existing topography, soils, and drainage patterns.
- Emphasize erosion control rather than sediment control.
- Minimize the extent and duration of the area exposed.
- Keep runoff velocities low.
- Retain sediment on site.
- Thoroughly monitor site and maintain all ESC measures.
- Schedule major earthwork during the dry season.

The project will be managed according to the following key project components:

Phasing of Construction

The project is proposed to be completed in one phase.

Seasonal Work Limitations

From October 1 through April 30, clearing, grading, and other soil disturbing activities shall only be permitted if shown to the satisfaction of the local permitting authority that silt-laden runoff will be prevented from leaving the site through a combination of the following:

- Site conditions including existing vegetative coverage, slope, soil type, and proximity to receiving waters; and
- Limitations on activities and the extent of disturbed areas; and
- Proposed erosion and sediment control measures.

Based on the information provided and/or local weather conditions, the local permitting authority may expand or restrict the seasonal limitation on site disturbance.

The following activities are exempt from the seasonal clearing and grading limitations:

- Routine maintenance and necessary repair of erosion and sediment control BMPs;
- Routine maintenance of public facilities or existing utility structures that do not expose the soil or result in the removal of the vegetative cover to soil; and
- Activities where there is 100 percent infiltration of surface water runoff within the site in approved and installed erosion and sediment control facilities.

Coordination with Utilities and Other Jurisdictions

Care has been taken to coordinate with utilities, other construction projects, and the local jurisdiction in preparing this SWPPP and scheduling the construction work.

Inspection and Monitoring

All BMPs shall be inspected, maintained, and repaired as needed to assure continued performance of their intended function. Site inspections shall be conducted by a person who is knowledgeable in the principles and practices of erosion and sediment control. This person has the necessary skills to:

- Assess the site conditions and construction activities that could impact the quality of stormwater, and
- Assess the effectiveness of erosion and sediment control measures used to control the quality of stormwater discharges.

A Certified Erosion and Sediment Control Lead shall be on-site or on-call at all times.

Whenever inspection and/or monitoring reveals that the BMPs identified in this SWPPP are inadequate, due to the actual discharge of or potential to discharge a significant amount of any pollutant, appropriate BMPs or design changes shall be implemented as soon as possible.

Maintaining an Updated Construction SWPPP

This SWPPP shall be retained on-site or within reasonable access to the site.

The SWPPP shall be modified whenever there is a change in the design, construction, operation, or maintenance at the construction site that has, or could have, a significant effect on the discharge of pollutants to waters of the state.

The SWPPP shall be modified if, during inspections or investigations conducted by the owner/operator, or the applicable local or state regulatory authority, it is determined that the SWPPP is ineffective in eliminating or significantly minimizing pollutants in stormwater discharges from the site. The SWPPP shall be modified as necessary to include additional or modified BMPs designed to correct problems identified. Revisions to the SWPPP shall be completed within seven (7) days following the inspection.

13. Protect Low Impact Development BMPs

The existing soil beneath the proposed non-infiltrating bioretention planters in the eastern and western portion of the site will be flagged to avoid over-compaction.

See Appendix B – Onsite Plans for TESC Plans and additional details.

9.0 – APPENDICES

Appendix A – Onsite Basin Map

24" x 36" 5/23/2023 U:\C3D\2019\2019094\ENGINEERING\EXHIBITS\DRAINAGE BASIN MAPS\ON-SITE BASIN MAP-DWG

- ROOF AREAS:**
- - - - - BUILDING ROOF TO BIOPANTERS = 6,466 SF (0.15 AC)
 - SUB BASIN I (BP A) = 2,657SF
 - SUB BASIN II (BP B) = 1,829SF
 - SUB BASIN III (BP C) = 451SF
 - SUB BASIN IV (BP D) = 1,529SF
- BIORETENTION PLANTERS**
- (BP A) = 6,288 SF CONTRIBUTING AREA
 - (BP B) = 1,829 SF CONTRIBUTING AREA
 - (BP C) = 451 SF CONTRIBUTING AREA
 - (BP D) = 1,529 SF CONTRIBUTING AREA
- NEW AND REPLACED IMPERVIOUS AREAS:**
- IMPERVIOUS PAVEMENT (PGHS) (SUB BASIN V) - (BP A) = 3,457 SF (0.08 AC)
 - NEW POOL WATER SURFACE (DRAINS TO SEWER) = 684 SF (0.01 AC)
 - PATIO PAVERS (BP A) = 278 SF (0.004 AC)
 - NEW LANDSCAPING (GRASS) = 1,452 SF
- NEW PERVIOUS AREAS**
- TOTAL SITE AREA = 27,481 SF (0.63 AC)
- TOTAL NEW AND REPLACED HARD SURFACE = 10,781 SF (0.25 AC)
- EXISTING IMPERVIOUS AREA TO REMAIN:**
- EXISTING DRIVEWAY = 735 SF
 - DRAINS TO PLANTER A



BUSH, ROED & HITCHINGS, INC.
 LAND SURVEYORS & CIVIL ENGINEERS
 2009 MINOR AVE. EAST
 SEATTLE, WASHINGTON 98102-3513
 (206) 323-4144
 1-800-935-0508
 FAX# (206) 323-7135



NO.	REVISION	DATE

ONSITE BASIN MAP
 8822 S.E. 62ND STREET
 HEADRICK RESIDENCE
 MERCER ISLAND KING COUNTY WASHINGTON

drawn by	checked by
MFM	TFD
scale	date
NO SCALE	05/17/23
job no.	
2019094.00	
sheet	of
1	1

Appendix B – Onsite Plans

24"x36" 5/23/2023 U:\C3D\2019\2019094\ENGINEERING\0-PLAN SHEETS\0-ERO-2ND PERMIT.DWG

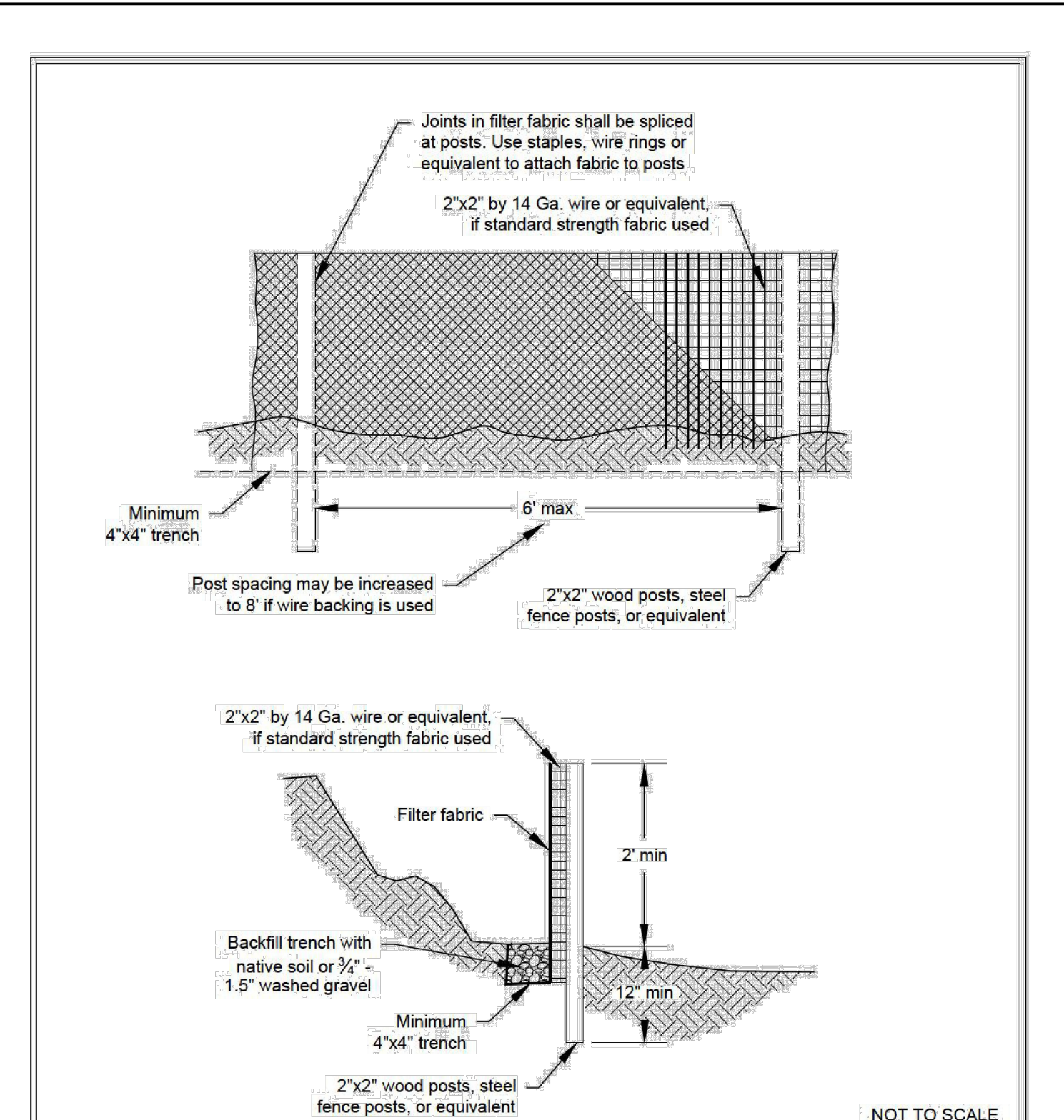
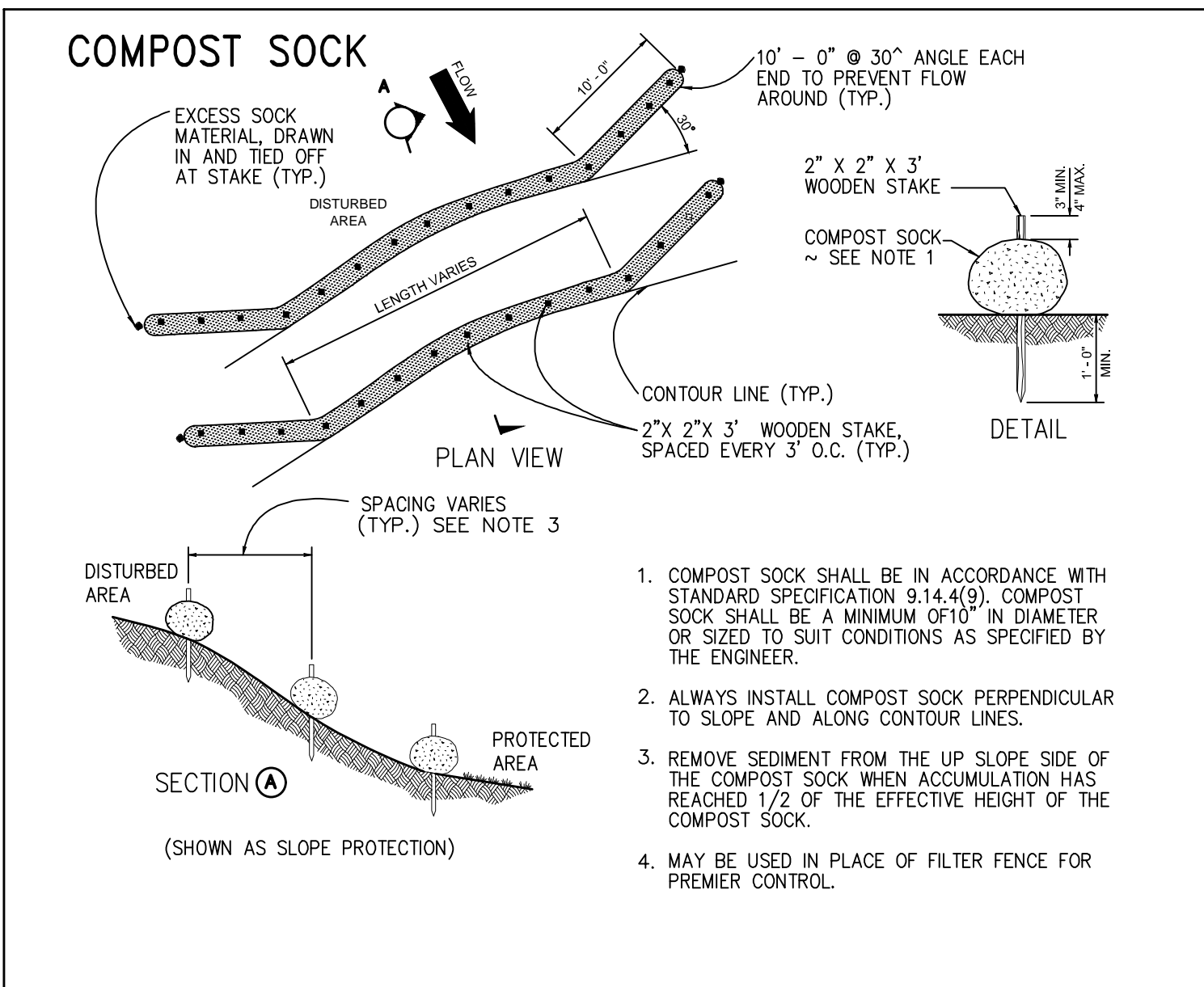
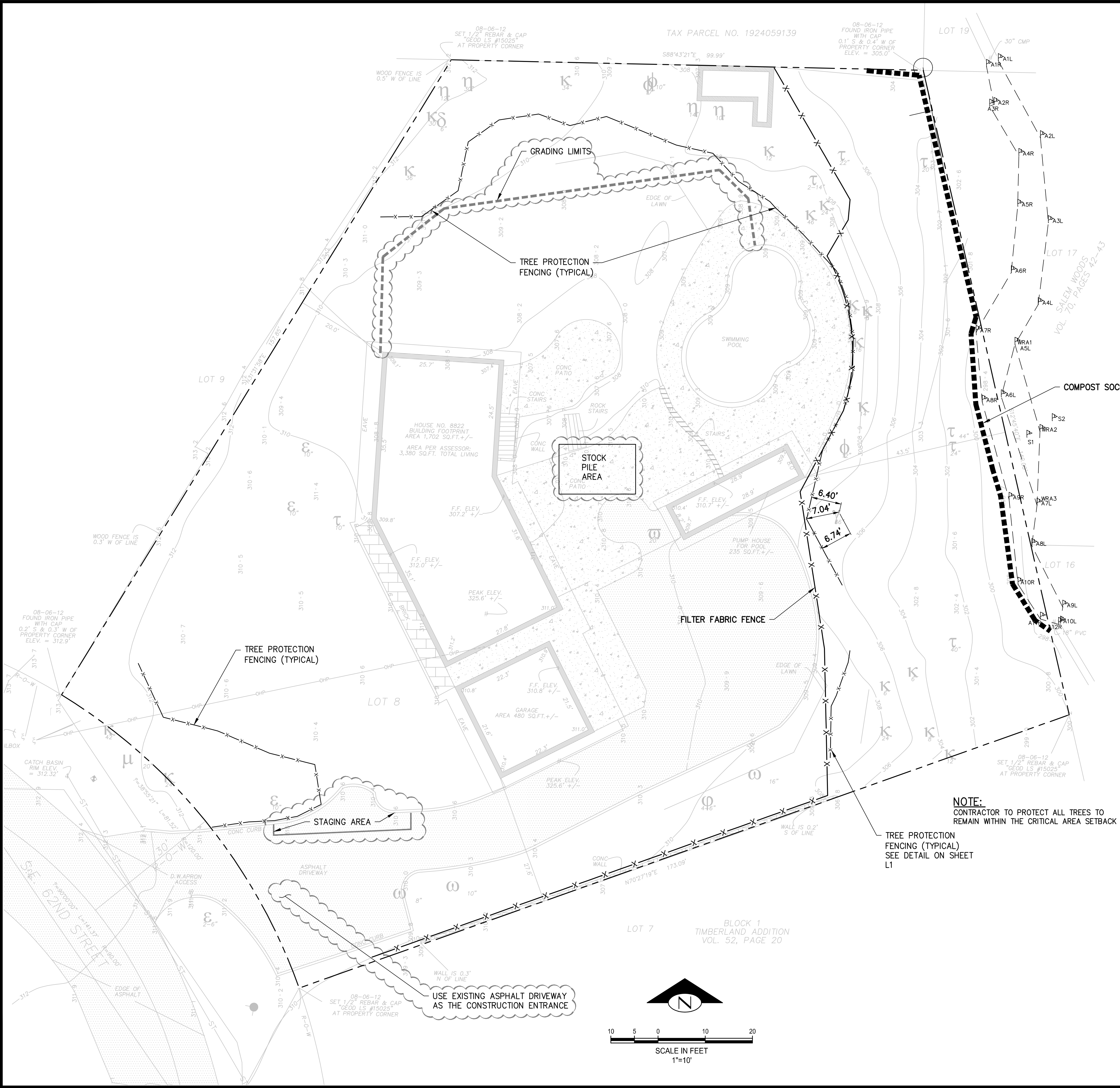
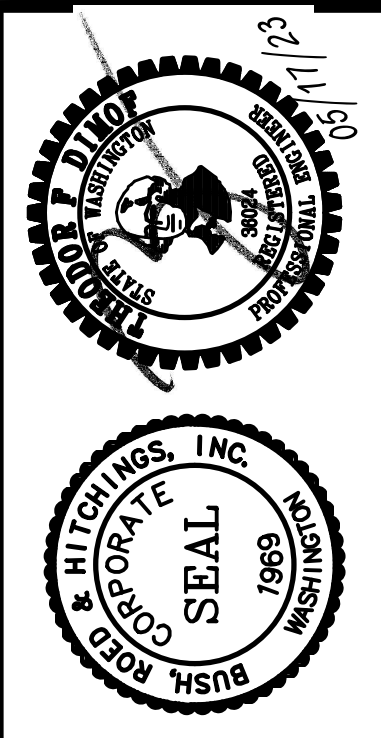
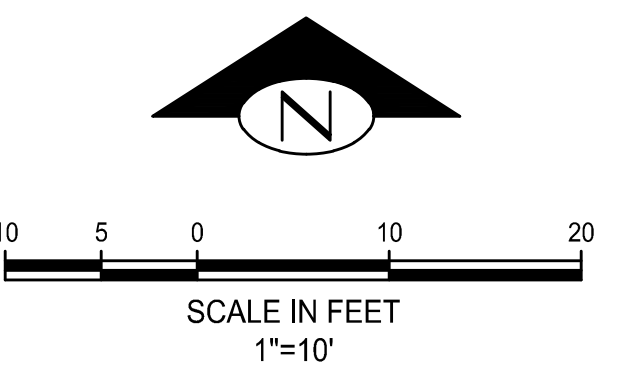

Figure II-4.2.12
Silt Fence
Revised October 2014
Please see <http://www.ecy.wa.gov/copyright.html> for copyright notice including permissions, limitation of liability, and disclaimer.



BUSH, ROED & HITCHINGS, INC.
LAND SURVEYORS & CIVIL ENGINEERS
2009 MINOR AVE. EAST
SEATTLE, Washington
1-800-935-0508
98102-3513
FAX# (206) 323-7135
(206) 323-4144



NO.	REVISION	DATE

EROSION CONTROL PLAN
8822 S.E. 62ND STREET
HEADRICK RESIDENCE
MERCER ISLAND KING COUNTY WASHINGTON

drawn by	checked by
WPG	TFD
scale	date
AS SHOWN	05/17/23
job no.	2019094.00
sheet	C1



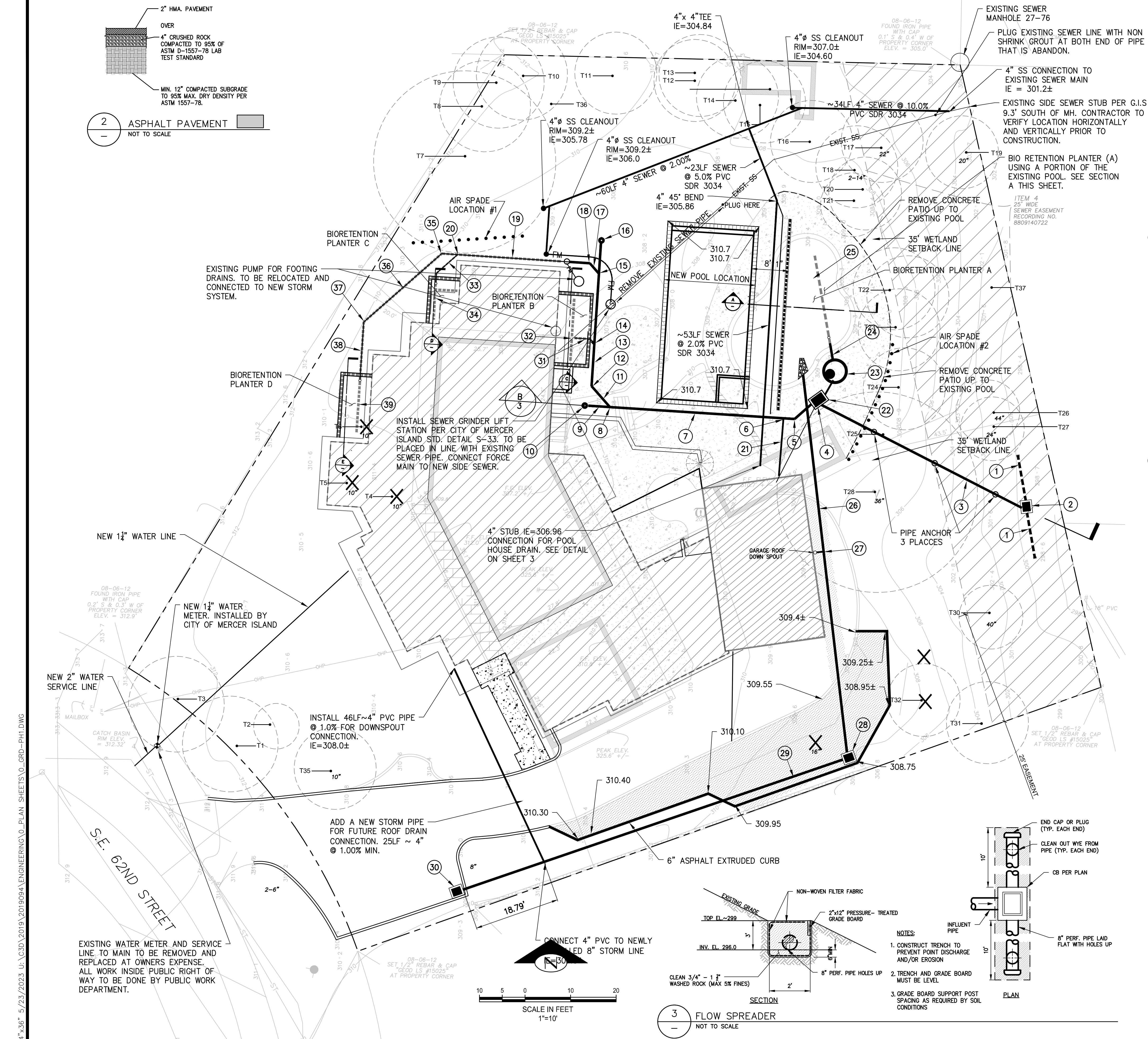
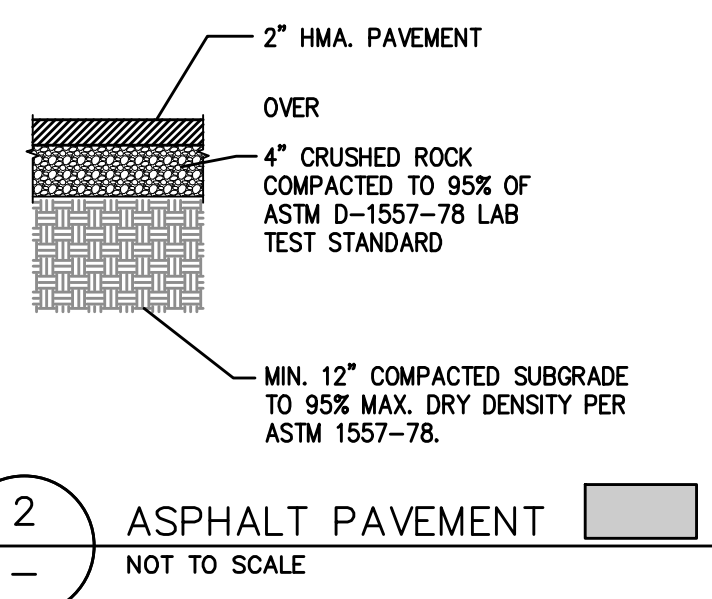

- STORM DRAINAGE NOTES:
- 1 FLOW SPREADER (3)
 - 2 TYPE I CB W/ SOLID LID RIM=299.0± IE=296.0±, 8" W IN IE=296.0±, 8" N OUT IE=296.0±, 8" S OUT
 - 3 47LF ~ 8" HDPE FUSE WELDED LAID ON THE HILLSIDE SLOPE @ EXISTING GRADE.
 - 4 TYPE 26 INLET W/SOLID LID RIM=309.0± IE=307.72, 6" PVC, W IN IE=307.72, 8" HDPE, E OUT
 - 5 6" 45° BEND IE=307.77
 - 6 6" X 4" TEE IE=307.80, 4" S GARAGE FOOTING DRAIN CONNECTION
 - 7 38LF ~ 6" PVC @ 1.0%
 - 8 6" X 6" WYE IE=308.18
 - 9 2LF ~ 8" PVC @ 1.0%
 - 10 6" CLEANOUT RIM=309.0± IE=308.2
 - 11 2LF ~ 6" PVC @ 1.0%
 - 12 6" 45° BEND IE=308.24
 - 13 29LF 6" @ 1.0%
 - 14 6" X 4" WYE IE=308.34
 - 15 6" X 4" WYE IE=308.48
 - 16 6" CLEANOUT RIM=310.0± IE=308.50
 - 17 3LF 4" @ 1.0%
 - 18 4" 45° BEND IE=308.53
 - 19 32LF 4" @ 1.0%
 - 20 4" WYE IE=308.83 OUTLET CONNECTION FOR BIO-RETENTION PLANTER 'C'
 - 21 12LF 4" PVC SOLID PIPE @ 1.0% FOR FOOTING GARAGE FOOTING DRAIN ONLY.
 - 22 1" Ø PVC FORCE MAIN FROM PUMP STATION
 - 23 PUMP STATION TYPE II 54" Ø CATCHBASIN W/SOLID LID RIM=309.2± IE=306.50, 1" FM IE=303.94, 4"
 - 24 14LF 4" PVC @ 1.0% MIN. INSIDE BIO RETENTION PLANTER 4" IE=304.0
 - 25 4" Ø PERFORATED PIPE @ 0.0% ELEVATION = 304.0
 - 26 89LF 8" @ 1.0%
 - 27 8" X 4" TEE IE=308.43 GARAGE ROOF DRAIN CONNECTION
 - 28 TYPE I CB W/ GRATE LID RIM=308.75± IE=306.87 8" W IN IE=306.87 8" N OUT
 - 29 89LF 8" PVC @ 1.0%
 - 30 TYPE I CB W/ GRATE LID RIM=309.8 IE=307.76, 8" E OUT
 - 31 4LF ~ 4" PVC @ 2.0% MIN.
 - 32 18LF ~ 4" Ø PERFORATED PIPE @ 0.0% IE = 308.36 CAP BOTH ENDS OF PIPE
 - 33 4LF ~ 4" PVC @ 2.0% MIN.
 - 34 11LF ~ 4" Ø PERFORATED PIPE @ 0.0% IE = 308.88 CAP BOTH ENDS OF PIPE
 - 35 4" 45° BEND IE=309.06
 - 36 23LF ~ 4" PVC @ 1.0% MIN.
 - 37 4" 45° BEND IE=309.06
 - 38 13LF ~ 4" PVC @ 1.0% MIN.
 - 39 11LF ~ 4" Ø PERFORATED PIPE @ 0.0% IE = 308.201 CAP END OF PIPE

TREE PROTECTION NOTE:

CONTRACTOR TO PROTECT ALL TREES TO REMAIN WITHIN THE CRITICAL AREA SETBACK. CONTRACTOR TO CALL OUT ARBORIST ON SITE DURING ANY EXCAVATION WITHIN THE TREE DRILINES.

AREA #1 AIR SPADE WORK AT SITE ONE WAS TO A DEPTH OF 18". TWO ROOTS FROM TREE 7 WERE FOUND 2" IN DIAMETER, NUMEROUS FIBROUS ROOTS WERE ALSO FOUND. PROPER CUTTING OF THESE ROOTS BY HAND WILL NOT ADVERSELY AFFECT THE TREE. APPLICATION OF MULCH OVER THE REMAINING ROOT SYSTEM AND APPLICATION OF FERTILIZER IN ADVANCE OF CONSTRUCTION WILL HELP THE TREE OVERCOME ANY STRESS FROM ROOT PRUNING.

AREA #2 AIR SPADE WORK TO 18" IN DEPTH SHOWED THAT ROOTS FROM THE NEARBY TREES HAS BEEN RESTRICTED BY THE CURRENT CONCRETE PAD WITH ROOTS RUNNING UP TO AND ALONG THE EDGE OF THE PAD. THE LOCATION OF THE DRAINAGE IS EXPECTED TO HAVE MINIMAL EFFECT ON ROOTS THAT HAVE MANAGED TO GROW TO THE LOCATION. MINOR ADJUSTMENT OF THE DRAIN LOCATION AT THE TIME OF INSTALLATION WILL FURTHER MINIMIZE ROOT ENCROACHMENT. MULCHING AND FERTILIZER APPLICATION AND POSSIBLE ROOT PRUNING IN ADVANCE OF CONSTRUCTION WILL HELP WITH ANY TREE STRESS.

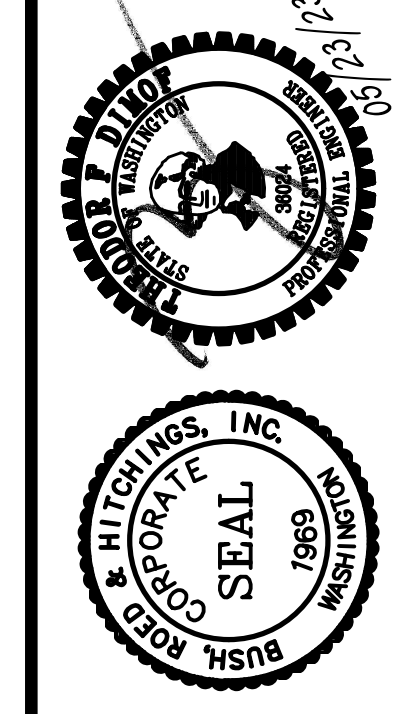
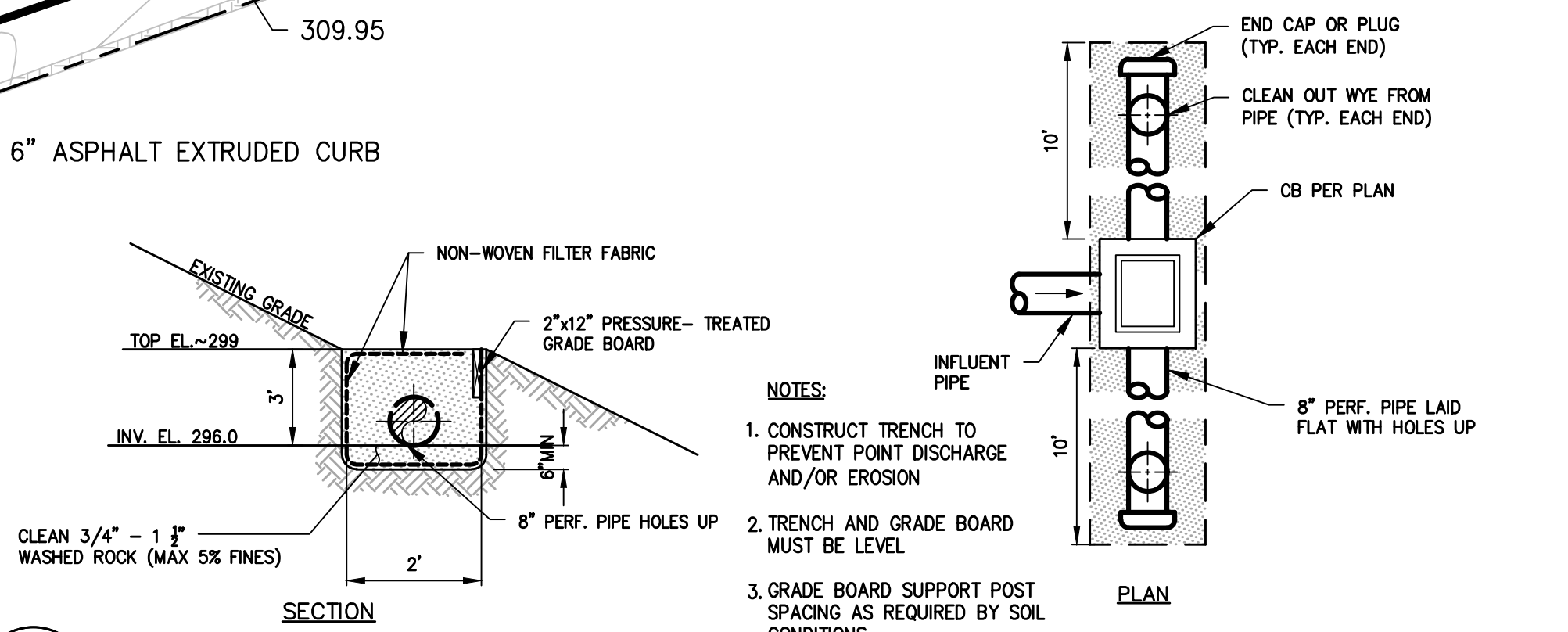

BUSH, ROED & HITCHINGS, INC.
 LAND SURVEYORS & CIVIL ENGINEERS
 2009 MINOR AVE. EAST
 SEATTLE, Washington
 (206) 323-4144
 1-800-935-0508
 98102-3513
 FAX# (206) 323-7135



DATE	
REVISION	
NO.	

STORM DRAINAGE PLAN	WASHINGTON
8822 S.E. 62ND STREET	
HEADRICK RESIDCE	
MERCER ISLAND	KING COUNTY
drawn by WPG	checked by TFD
scale AS SHOWN	date 05/23/23
job no. 2019094.00	
sheet C2	



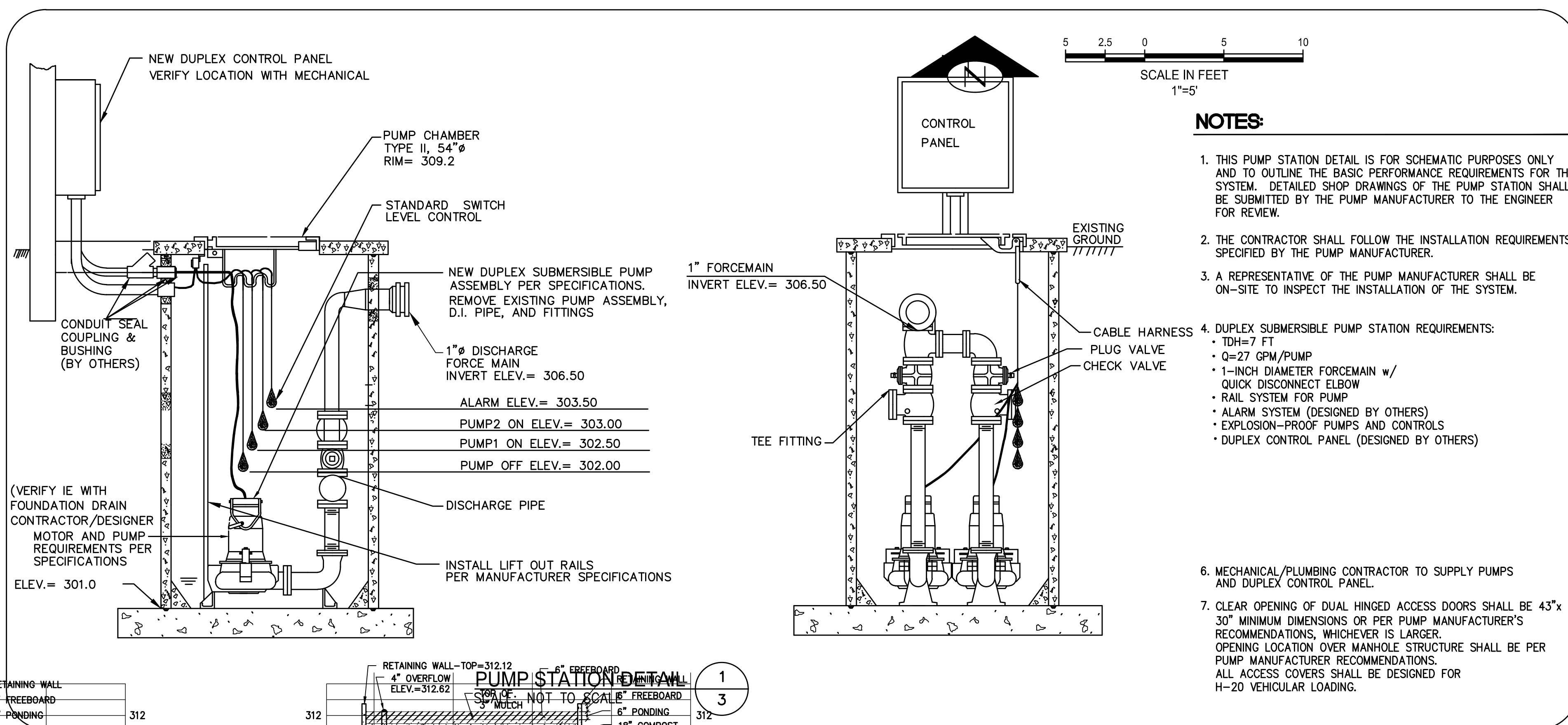
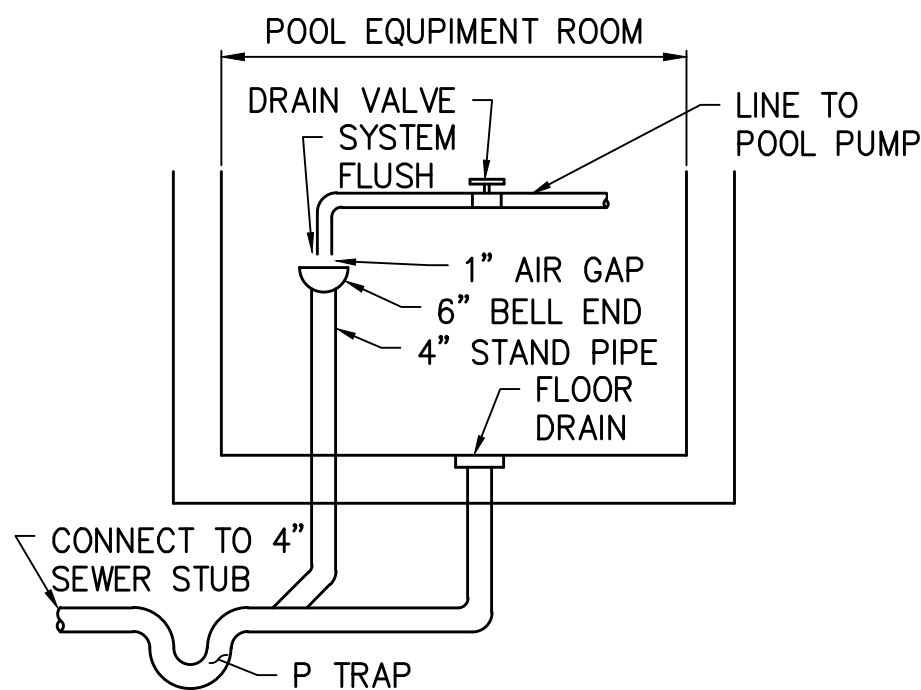
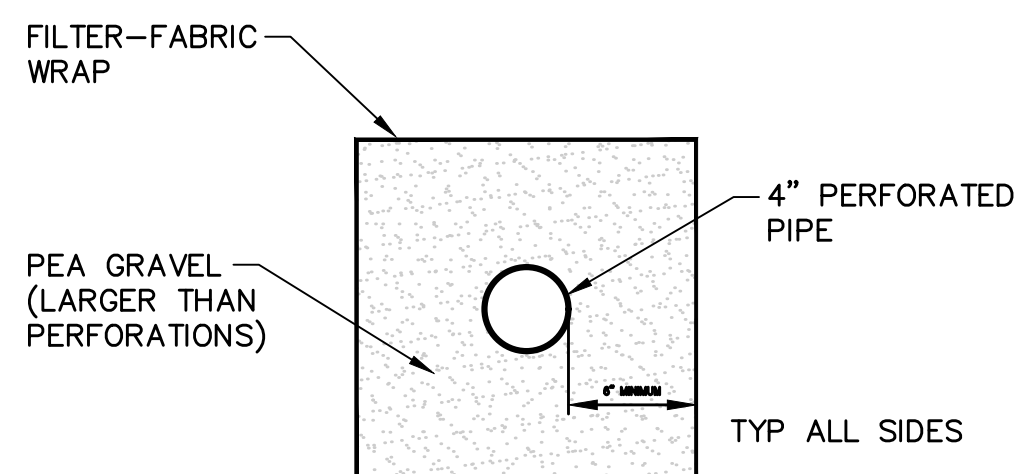
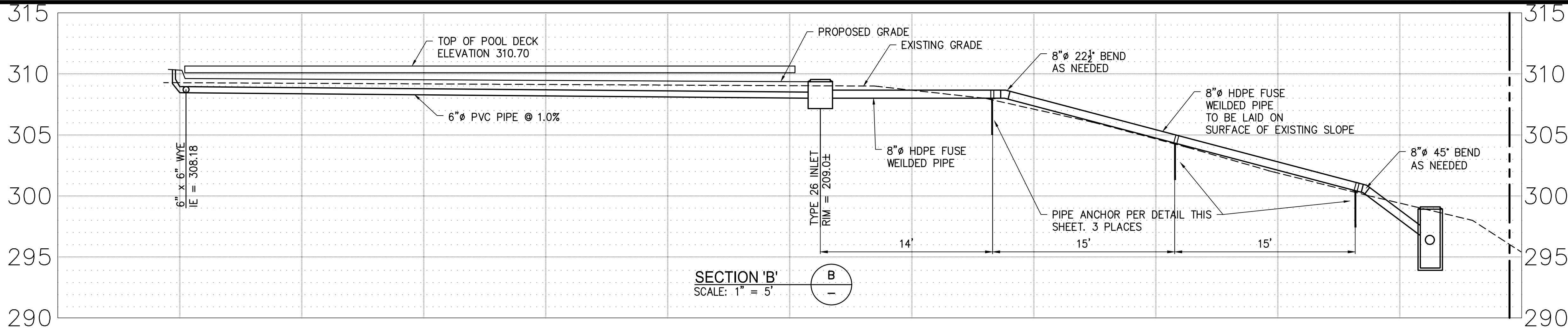
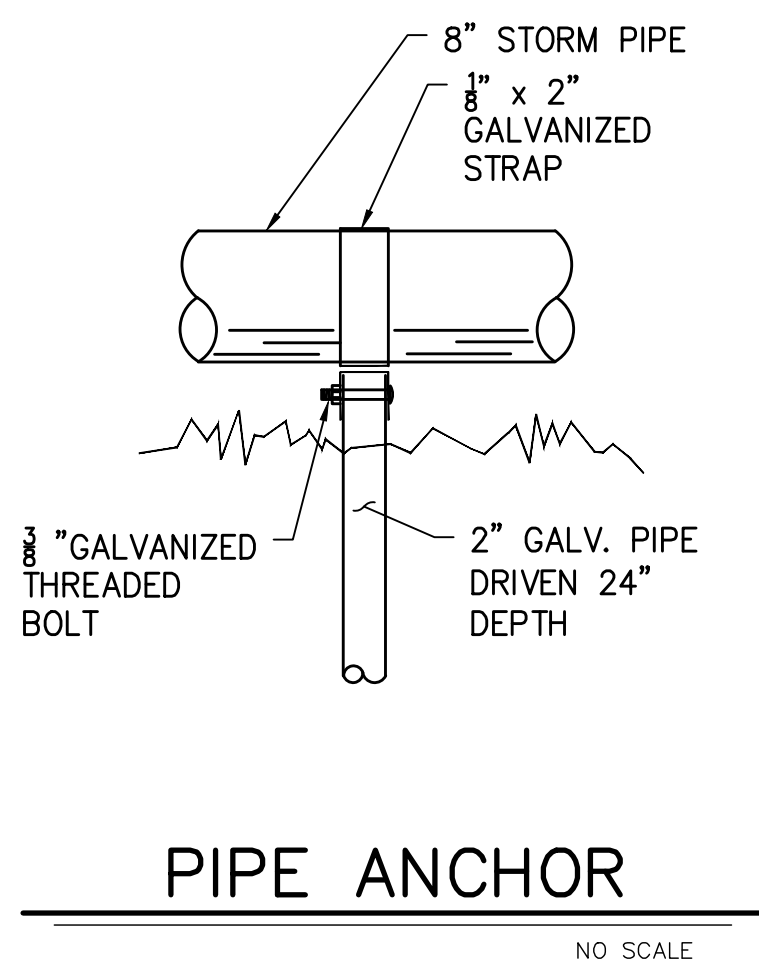

BIO RETENTION PLANT LIST
05.12.2023

QTY	BOTANICAL NAME	COMMON NAME	SIZE / SPACING	NOTES
SHRUBS & PERENNIALS				
5	CORNUS SERICEA	RED TWIGGED DOGWOOD	5 GAL / 5' OC	FULL, WELL-ROOTED
13	CAREX OBNUPTA	SLOUGH SEDGE	1 GAL / 2' OC	FULL, WELL-ROOTED
18	CAMAS LEICHTLINII	GIANT CAMAS	1 GAL / 18" OC	FULL, WELL-ROOTED
5	IRIS DOUGLASSIANA	DOUGLAS IRIS	1 GAL / 2' OC	FULL, WELL-ROOTED

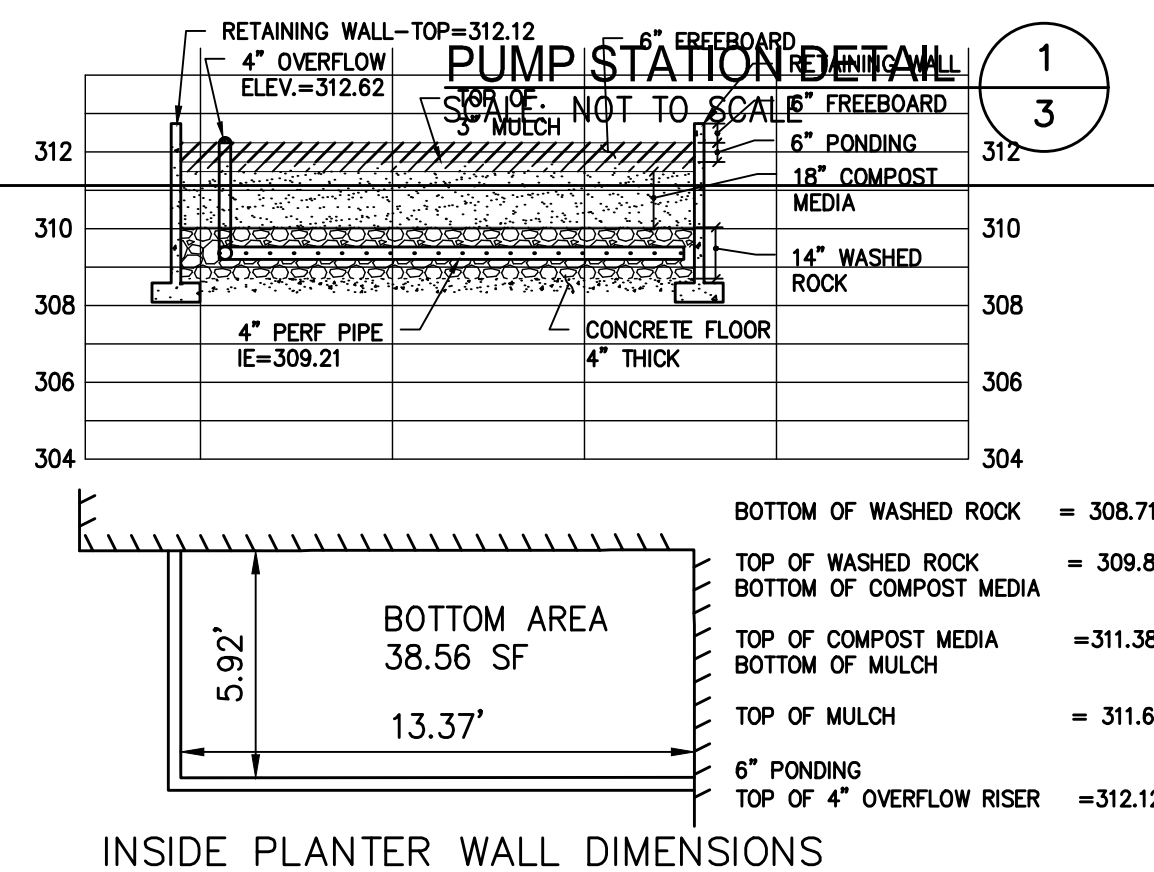
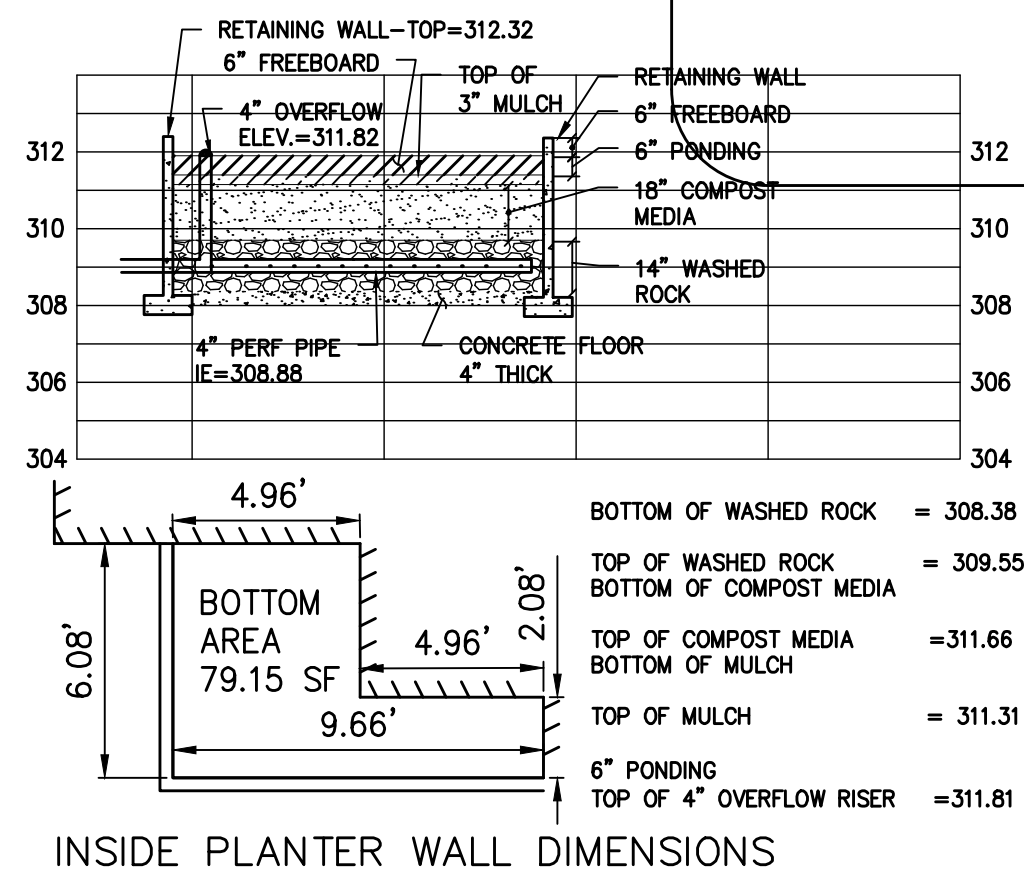
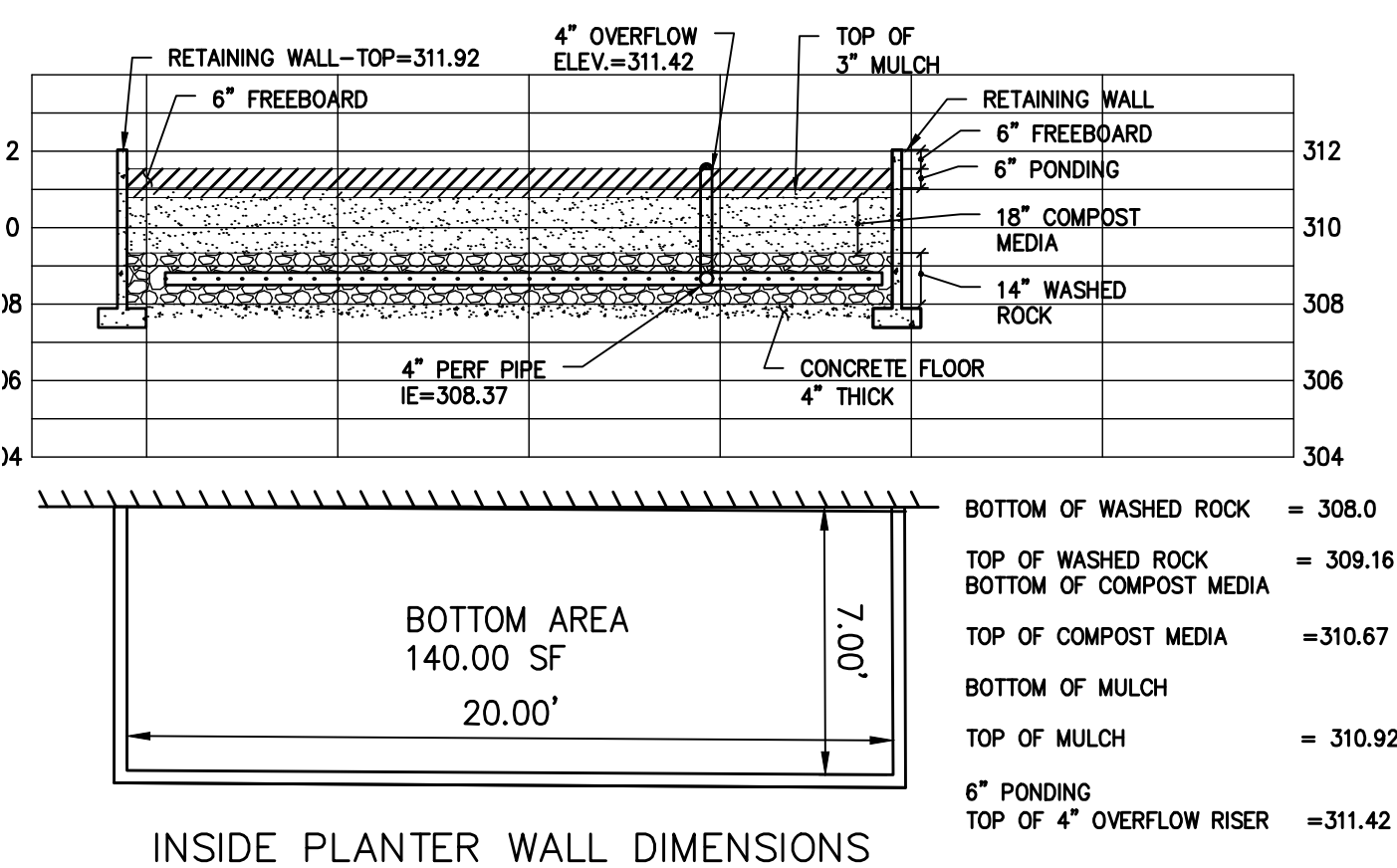

24"x36" 5/23/2023 U:\C3D\2019\2019094\ENGINEERING\0-PLAN SHEETS\0-GRD-PH1.DWG

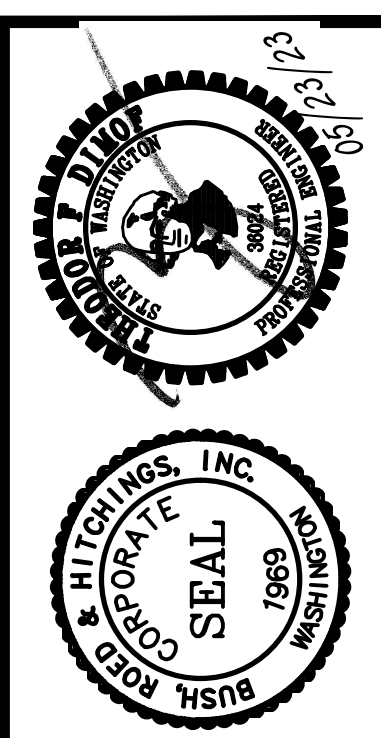

BUSH, ROED & HITCHINGS, INC.
LAND SURVEYORS & CIVIL ENGINEERS
2009 MINOR AVE EAST
SEATTLE, WASHINGTON 98102-3513
(206) 328-4144
1-800-938-0508
FAX# (206) 323-7136



DATE	
REVISION	
NO.	

STORM DRAINAGE DETAILS
8822 S.E. 62ND STREET
HEADRICK RESIDENCE
MERCER ISLAND KING COUNTY WASHINGTON

drawn by	checked by
WPG	TFD
scale	date
AS SHOWN	05/23/23
job no.	2019094.00
sheet	C3



Appendix C – Geotechnical Report

March 20, 2019

JN 19086

Jennifer Headrick
8822 Southeast 62nd Street
Mercer Island, Washington 98040
via email: jenheadrick@hotmail.com

Subject: **Geotechnical Engineering Study**
Proposed Detached Garage and Pool Project
8822 Southeast 62nd Street
Mercer Island, Washington

Dear Ms. Headrick:

We are pleased to submit this geotechnical engineering report for the proposed detached garage and pool project to be constructed in Mercer Island, Washington. The scope of our services consisted of exploring site surface and subsurface conditions, and then developing this report to provide recommendations for general earthwork and design considerations for foundations, retaining walls, subsurface drainage, and temporary excavations. This work was authorized by your acceptance of our proposal, P-10315, dated March 6, 2019.

We were provided with a site plan and a topographic map. Based on this information, we understand that the development will consist of constructing a detached garage and storage building on the southeastern portion of the site (this assumes that the street is located on the western side of the site), as well as a new, 5-foot-deep pool on the northeastern portion of the site. These will be located about 40 to 45 feet west of the eastern property line. In addition, some additional driveway will be added at the southern edge of a portion of the site. The ground in the area of these proposed structures is relatively flat, and we expect the slab grade of the proposed garage and the pool deck level will be near the grade of the existing ground.

If the scope of the project changes from what we have described above, we should be provided with revised plans in order to determine if modifications to the recommendations and conclusions of this report are warranted.

SITE CONDITIONS

SURFACE

The site is located on near the middle of Mercer Island, just east of Island Crest Way. The site is located near the corner of Southeast 62nd Street and 89th Avenue Southeast. The site is somewhat northeast of this corner, but for ease of description, this report assumes that street is on the western side of the site.

The site is nearly flat with just a very gentle slope down to the east. However, a steep slope that is about 8 feet tall is located at the eastern edge of the site. Apparently, there is a small, seasonal drainage course located at the base of the slope. A residence, garage, shed, pool, and patio are

located on the central portion of the site. An asphalt driveway is located along much of the southern side of the site that is nearly flat. Some lawn areas are located on the northern and northwestern portions of the site. There are some scattered, large evergreen trees in the area of the steep eastern slope.

SUBSURFACE

The subsurface conditions were explored by excavating three test pits and two test holes at the approximate locations shown on the Site Exploration Plan, Plate 2. Our exploration program was based on the proposed construction, anticipated subsurface conditions and those encountered during exploration, and the scope of work outlined in our proposal.

The test pits and test holes were excavated on March 12, 2019. The test pits were excavated with a small tracked excavator, while the test holes were excavated with hand equipment. A geotechnical engineer from our staff observed the excavation process of the test pits, logged the explorations, and obtained representative samples of the soil encountered. "Grab" samples of selected subsurface soil were collected from the backhoe bucket and/or hand equipment. The Test Pit Logs are attached to this report as Plates 3 and 4, while the Test Hole Logs are attached as Plate 5.

Soil Conditions

The test pits were excavated on the southern portion of the site, nearer the proposed location of the detached garage. These test pits encountered about 2 to 4 feet of loose fill soil and/or topsoil at the ground surface. Native, gravelly silty sand was revealed below these soils. This soil was initially loose, but became dense at depths of about 5 feet in two of the test pits. The loose soil was still encountered to the maximum explored depth of 6 feet in one test pit, but we would expect the soil to become dense within a maximum of a few feet below the maximum explored depth. The dense soil is geologically known as Glacial Till; this soil is typical in upland areas of the Puget Sound region. This dense Glacial Till was revealed at depths of approximately 1.5 to 3.5 feet in the test holes that were excavated closer to the proposed pool area.

Groundwater Conditions

Some perched groundwater seepage was observed at a depth of 4 feet in one of the five explorations. However, the explorations were left open for only a short time period; therefore, the seepage levels on the logs represent the location of transient water seepage and may not indicate the static groundwater level. It should be noted that groundwater levels vary seasonally with rainfall and other factors, with levels and amounts being higher in the winter and early spring months. Thus, it is possible that groundwater will be revealed perched on the dense glacial till soil during these months.

The stratification lines on the logs represent the approximate boundaries between soil types at the exploration locations. The actual transition between soil types may be gradual, and subsurface conditions can vary between exploration locations. The logs provide specific subsurface information only at the locations tested. The relative densities and moisture descriptions indicated on the test pit logs are interpretive descriptions based on the conditions observed during excavation.

The compaction of test pit backfill was not in the scope of our services. The test pits were backfilled with excavated soil that was lightly tamped into place. Loose soil will therefore be found in the area of the test pits. If this presents a problem, the backfill will need to be removed and replaced with structural fill during construction.

CONCLUSIONS AND RECOMMENDATIONS

GENERAL

THIS SECTION CONTAINS A SUMMARY OF OUR STUDY AND FINDINGS FOR THE PURPOSES OF A GENERAL OVERVIEW ONLY. MORE SPECIFIC RECOMMENDATIONS AND CONCLUSIONS ARE CONTAINED IN THE REMAINDER OF THIS REPORT. ANY PARTY RELYING ON THIS REPORT SHOULD READ THE ENTIRE DOCUMENT.

The test pits and test holes conducted for this study encountered dense Glacial Till soil at depths ranging from about 1.5 to greater than 6 feet. Loose soil was revealed above the Glacial Till. The more shallow depths of the Glacial Till were revealed in the area of the proposed pool, but depths of about 5 feet or more were revealed in the area of the proposed garage. The proposed garage and pool should bear on the Glacial Till or structural fill that is placed over the Glacial Till. It appears that the proposed excavations for the pool will likely reach to or into the Glacial Till, although some structural fill may be needed if the base of the old pool is deeper than the new pool. The depth to the Glacial Till is at least 5 feet deep in the area of the proposed garage based on the test pits. Because of this depth, it is likely more economically feasible to place the garage on driven pipe piles that embed into the Glacial Till in lieu of making the over-excavations necessary to reach the Glacial Till. We have provided information regarding driven pipe piles, as well as footing foundation, in this report.

In order to satisfy the City of Mercer Island's requirements for Geologic Hazard Areas, a "statement of risk" for the project is required. As such, we make the following statement:

Provided the recommendations in this report are followed, it is our professional opinion that the development can be constructed so that the risk to the lot and adjacent property is mitigated such that the site is determined to be safe.

The erosion control measures needed during the site development will depend heavily on the weather conditions that are encountered. We anticipate that a silt fence will be needed around the downslope sides of any cleared areas. Existing pavements, ground cover, and landscaping should be left in place wherever possible to minimize the amount of exposed soil. Rocked staging areas and construction access roads should be provided to reduce the amount of soil or mud carried off the property by trucks and equipment. Wherever possible, the access roads should follow the alignment of planned pavements. Trucks should not be allowed to drive off of the rock-covered areas. Cut slopes and soil stockpiles should be covered with plastic during wet weather. Following clearing or rough grading, it may be necessary to mulch or hydroseed bare areas that will not be immediately covered with landscaping or an impervious surface. On most construction projects, it is necessary to periodically maintain or modify temporary erosion control measures to address specific site and weather conditions.

Geotech Consultants, Inc. should be allowed to review the final development plans to verify that the recommendations presented in this report are adequately addressed in the design. Such a plan review would be additional work beyond the current scope of work for this study, and it may include

revisions to our recommendations to accommodate site, development, and geotechnical constraints that become more evident during the review process.

We recommend including this report, in its entirety, in the project contract documents. This report should also be provided to any future property owners so they will be aware of our findings and recommendations.

SEISMIC CONSIDERATIONS

In accordance with the International Building Code (IBC), the site class within 100 feet of the ground surface is best represented by Site Class Type C (Very Dense Soil). As noted in the USGS website, the mapped spectral acceleration value for a 0.2 second (S_s) and 1.0 second period (S_1) equals 1.45g and 0.56g, respectively.

The IBC and ASCE 7 require that the potential for liquefaction (soil strength loss) during an earthquake be evaluated for the peak ground acceleration of the Maximum Considered Earthquake (MCE), which has a probability of occurring once in 2,475 years (2 percent probability of occurring in a 50-year period). The MCE peak ground acceleration adjusted for site class effects (F_{PGA}) equals 0.60g. The soils beneath the site are not susceptible to seismic liquefaction under the ground motions of the MCE because of their dense nature and/or the absence of near-surface groundwater.

Sections 1803.5 of the IBC and 11.8 of ASCE 7 require that other seismic-related geotechnical design parameters (seismic surcharge for retaining wall design and slope stability) include the potential effects of the Design Earthquake. The peak ground acceleration for the Design Earthquake is defined in Section 11.2 of ASCE 7 as two-thirds (2/3) of the MCE peak ground acceleration, or 0.40g.

PIPE PILES

Three- or 4-inch-diameter pipe piles driven with a 850- or 1,100- or 2,000-pound hydraulic jackhammer to the following final penetration rates may be assigned the following compressive capacities.

INSIDE PILE DIAMETER	FINAL DRIVING RATE (850-pound hammer)	FINAL DRIVING RATE (1,100-pound hammer)	FINAL DRIVING RATE (2,000-pound hammer)	ALLOWABLE COMPRESSIVE CAPACITY
3 inches	10 sec/inch	6 sec/inch	2 sec/inch	6 tons
4 inches	16 sec/inch	10 sec/inch	4 sec/inch	10 tons

Note: The refusal criteria indicated in the above table are valid only for pipe piles that are installed using a hydraulic impact hammer carried on leads that allow the hammer to sit on the top of the pile during driving. If the piles are installed by alternative methods, such as a vibratory hammer or a hammer that is hard-mounted to the installation machine, numerous load tests to 200 percent of the design capacity would be necessary to substantiate the

allowable pile load. The appropriate number of load tests would need to be determined at the time the contractor and installation method are chosen.

As a minimum, Schedule 40 pipe should be used. The site soils are not highly organic, and are not located near salt water. As a result, they do not have an elevated corrosion potential. Considering this, it is our opinion that standard "black" pipe can be used, and corrosion protection, such as galvanizing, is not necessary for the pipe piles.

We recommend a minimum pile length of 5 feet below the existing ground. However, based on the test pits, the piles are likely to extend to an average depth of 10 feet.

Pile caps and grade beams should be used to transmit loads to the piles. Isolated pile caps should include a minimum of two piles to reduce the potential for eccentric loads being applied to the piles. Subsequent sections of pipe can be connected with slip or threaded couplers, or they can be welded together. If slip couplers are used, they should fit snugly into the pipe sections. This may require that shims be used or that beads of welding flux be applied to the outside of the coupler.

Lateral loads due to wind or seismic forces may be resisted by passive earth pressure acting on the vertical, embedded portions of the foundation. For this condition, the foundation must be either poured directly against relatively level, undisturbed soil or be surrounded by level compacted fill. We recommend using a passive earth pressure of 300 pounds per cubic foot (pcf) for this resistance. If the ground in front of a foundation is loose or sloping, the passive earth pressure given above will not be appropriate. We recommend a safety factor of at least 1.5 for the foundation's resistance to lateral loading, when using the above ultimate passive value.

If lateral resistance from fill placed against the foundations is required for this project, the structural engineer should indicate this requirement on the plans for the general and earthwork contractor's information. Compacted fill placed against the foundations can consist of on-site or imported soil that is tamped into place using the backhoe or is compacted using a jumping jack compactor. It is necessary for the fill to be compacted to a firm condition, but it does not need to reach even 90 percent relative compaction to develop the passive resistance recommended above.

CONVENTIONAL FOUNDATIONS

Structures can be supported on conventional continuous and spread footings bearing on undisturbed, dense, native Glacial Till soil, or on structural fill placed above this competent native soil. See the section entitled **General Earthwork and Structural Fill** for recommendations regarding the placement and compaction of structural fill beneath structures. Adequate compaction of structural fill should be verified with frequent density testing during fill placement. Prior to placing structural fill beneath foundations, the excavation should be observed by the geotechnical engineer to document that adequate bearing soils have been exposed.

We recommend that continuous and individual spread footings have minimum widths of 12 and 16 inches, respectively. Exterior footings should also be bottomed at least 18 inches below the lowest adjacent finish ground surface for protection against frost and erosion. The local building codes should be reviewed to determine if different footing widths or embedment depths are required. Footing subgrades must be cleaned of loose or disturbed soil prior to pouring concrete. Depending upon site and equipment constraints, this may require removing the disturbed soil by hand.

Depending on the final site grades, overexcavation may be required below the footings to expose competent native soil. Unless lean concrete is used to fill an overexcavated hole, the overexcavation must be at least as wide at the bottom as the sum of the depth of the overexcavation and the footing width. For example, an overexcavation extending 2 feet below the bottom of a 2-foot-wide footing must be at least 4 feet wide at the base of the excavation. If lean concrete is used, the overexcavation need only extend 6 inches beyond the edges of the footing.

An allowable bearing pressure of 3,000 pounds per square foot (psf) is appropriate for footings supported on soils as noted above native soil. A one-third increase in this design bearing pressure may be used when considering short-term wind or seismic loads. For the above design criteria, it is anticipated that the total post-construction settlement of footings founded on competent native soil, or on structural fill up to 5 feet in thickness, will be about one inch, with differential settlements on the order of one-half inch in a distance of 40 feet along a continuous footing with a uniform load.

Lateral loads due to wind or seismic forces may be resisted by friction between the foundation and the bearing soil, or by passive earth pressure acting on the vertical, embedded portions of the foundation. For the latter condition, the foundation must be either poured directly against relatively level, undisturbed soil or be surrounded by level, well-compacted fill. We recommend using the following ultimate values for the foundation's resistance to lateral loading:

PARAMETER	ULTIMATE VALUE
Coefficient of Friction	0.50
Passive Earth Pressure	300 pcf

Where: pcf is Pounds per Cubic Foot, and Passive Earth Pressure is computed using the Equivalent Fluid Density.

If the ground in front of a foundation is loose or sloping, the passive earth pressure given above will not be appropriate. The above ultimate values for passive earth pressure and coefficient of friction do not include a safety factor.

FOUNDATION AND RETAINING WALLS

Retaining walls backfilled on only one side should be designed to resist the lateral earth pressures imposed by the soil they retain. The following recommended parameters are for walls that restrain level backfill:

PARAMETER	VALUE
Active Earth Pressure *	35 pcf
Passive Earth Pressure	300 pcf
Coefficient of Friction	0.50
Soil Unit Weight	130 pcf

Where: pcf is Pounds per Cubic Foot, and Active and Passive Earth Pressures are computed using the Equivalent Fluid Pressures.

* For a restrained wall that cannot deflect at least 0.002 times its height, a uniform lateral pressure equal to 10 psf times the height of the wall should be added to the above active equivalent fluid pressure. This applies only to walls with level backfill.

The design values given above do not include the effects of any hydrostatic pressures behind the walls and assume that no surcharges, such as those caused by slopes, vehicles, or adjacent foundations will be exerted on the walls. If these conditions exist, those pressures should be added to the above lateral soil pressures. Where sloping backfill is desired behind the walls, we will need to be given the wall dimensions and the slope of the backfill in order to provide the appropriate design earth pressures. Heavy construction equipment should not be operated behind retaining and foundation walls within a distance equal to the height of a wall, unless the walls are designed for the additional lateral pressures resulting from the equipment.

The values given above are to be used to design only permanent foundation and retaining walls that are to be backfilled, such as conventional walls constructed of reinforced concrete or masonry. It is not appropriate to use the above earth pressures and soil unit weight to back-calculate soil strength parameters for design of other types of retaining walls, such as soldier pile, reinforced earth, modular or soil nail walls. We can assist with design of these types of walls, if desired.

The passive pressure given is appropriate only for a shear key poured directly against undisturbed native soil, or for the depth of level, well-compacted fill placed in front of a retaining or foundation wall. The values for friction and passive resistance are ultimate values and do not include a safety factor. Restrained wall soil parameters should be utilized the wall and reinforcing design for a distance of 1.5 times the wall height from corners or bends in the walls, or from other points of restraint. This is intended to reduce the amount of cracking that can occur where a wall is restrained by a corner.

Wall Pressures Due to Seismic Forces

The surcharge wall loads that could be imposed by the design earthquake can be modeled by adding a uniform lateral pressure to the above-recommended active pressure. The recommended surcharge pressure is $7H$ pounds per square foot (psf), where H is the design retention height of the wall. Using this increased pressure, the safety factor against sliding and overturning can be reduced to 1.2 for the seismic analysis.

Retaining Wall Backfill and Waterproofing

Backfill placed behind retaining or foundation walls should be coarse, free-draining structural fill containing no organics. This backfill should contain no more than 5 percent silt or clay particles and have no gravel greater than 4 inches in diameter. The later section entitled ***Drainage Considerations*** should also be reviewed for recommendations related to subsurface drainage behind foundation and retaining walls.

The purpose of these backfill requirements is to ensure that the design criteria for a retaining wall are not exceeded because of a build-up of hydrostatic pressure behind the wall. Also, subsurface drainage systems are not intended to handle large volumes of water from surface runoff. The top 12 to 18 inches of the backfill should consist of a compacted, relatively impermeable soil or topsoil, or the surface should be paved. The ground surface must also slope away from backfilled walls at one to 2 percent to reduce the potential for surface water to percolate into the backfill.

Water percolating through pervious surfaces (pavers, gravel, permeable pavement, etc.) must also be prevented from flowing toward walls or into the backfill zone. Foundation drainage and waterproofing systems are not intended to handle large volumes of infiltrated water. The compacted subgrade below pervious surfaces and any associated drainage layer should therefore be sloped away. Alternatively, a membrane and subsurface collection system could be provided below a pervious surface.

It is critical that the wall backfill be placed in lifts and be properly compacted, in order for the above-recommended design earth pressures to be appropriate. The recommended wall design criteria assume that the backfill will be well-compacted in lifts no thicker than 12 inches. The compaction of backfill near the walls should be accomplished with hand-operated equipment to prevent the walls from being overloaded by the higher soil forces that occur during compaction. The section entitled ***General Earthwork and Structural Fill*** contains additional recommendations regarding the placement and compaction of structural fill behind retaining and foundation walls.

The above recommendations are not intended to waterproof below-grade walls, or to prevent the formation of mold, mildew or fungi in interior spaces. Over time, the performance of subsurface drainage systems can degrade, subsurface groundwater flow patterns can change, and utilities can break or develop leaks. Therefore, waterproofing should be provided where future seepage through the walls is not acceptable. This typically includes limiting cold-joints and wall penetrations, and using bentonite panels or membranes on the outside of the walls. There are a variety of different waterproofing materials and systems, which should be installed by an experienced contractor familiar with the anticipated construction and subsurface conditions. Applying a thin coat of asphalt emulsion to the outside face of a wall is not considered waterproofing, and will only help to reduce moisture generated from water vapor or capillary action from seeping through the concrete. As with any project, adequate ventilation of basement and crawl space areas is important to prevent a buildup of water vapor that is commonly transmitted through concrete walls from the surrounding soil, even when seepage is not present. This is appropriate even when waterproofing is applied to the outside of foundation and retaining walls. We recommend that you contact an experienced envelope consultant if detailed recommendations or specifications related to waterproofing design, or minimizing the potential for infestations of mold and mildew are desired.

The **General, Slabs-On-Grade, and Drainage Considerations** sections should be reviewed for additional recommendations related to the control of groundwater and excess water vapor for the anticipated construction.

SLABS-ON-GRADE

The building floors can be constructed as slabs-on-grade atop non-organic, firm existing soil or on structural fill. The subgrade soil must be in a firm, non-yielding condition at the time of slab construction or underslab fill placement. Any soft areas encountered should be excavated and replaced with select, imported structural fill.

Even where the exposed soils appear dry, water vapor will tend to naturally migrate upward through the soil to the new constructed space above it. This can affect moisture-sensitive flooring, cause imperfections or damage to the slab, or simply allow excessive water vapor into the space above the slab. All interior slabs-on-grade should be underlain by a capillary break drainage layer consisting of a minimum 4-inch thickness of clean gravel or crushed rock that has a fines content (percent passing the No. 200 sieve) of less than 3 percent and a sand content (percent passing the No. 4 sieve) of no more than 10 percent. Pea gravel or crushed rock are typically used for this layer.

As noted by the American Concrete Institute (ACI) in the *Guides for Concrete Floor and Slab Structures*, proper moisture protection is desirable immediately below any on-grade slab that will be covered by tile, wood, carpet, impermeable floor coverings, or any moisture-sensitive equipment or products. ACI recommends a minimum 10-mil thickness vapor retarder for better durability and long term performance than is provided by 6-mil plastic sheeting that has historically been used. A vapor retarder is defined as a material with a permeance of less than 0.3 perms, as determined by ASTM E 96. It is possible that concrete admixtures may meet this specification, although the manufacturers of the admixtures should be consulted. Where vapor retarders are used under slabs, their edges should overlap by at least 6 inches and be sealed with adhesive tape. The sheeting should extend to the foundation walls for maximum vapor protection.

If no potential for vapor passage through the slab is desired, a vapor *barrier* should be used. A vapor barrier, as defined by ACI, is a product with a water transmission rate of 0.01 perms when tested in accordance with ASTM E 96. Reinforced membranes having sealed overlaps can meet this requirement.

We recommend that the contractor, the project materials engineer, and the owner discuss these issues and review recent ACI literature and ASTM E-1643 for installation guidelines and guidance on the use of the protection/blotter material.

The **General, Permanent Foundation and Retaining Walls, and Drainage Considerations** sections should be reviewed for additional recommendations related to the control of groundwater and excess water vapor for the anticipated construction.

EXCAVATIONS AND SLOPES

Temporary excavation slopes should not exceed the limits specified in local, state, and national government safety regulations. Also, temporary cuts should be planned to provide a minimum 2 to 3 feet of space for construction of foundations, walls, and drainage. Temporary cuts to a maximum

overall depth of about 4 feet may be attempted vertically in unsaturated soil, if there are no indications of slope instability. However, vertical cuts should not be made near property boundaries, or existing utilities and structures. Based upon Washington Administrative Code (WAC) 296, Part N, the upper soil at the subject site would generally be classified as Type B. Therefore, temporary cut slopes greater than 4 feet in height should not be excavated at an inclination steeper than 1:1 (Horizontal:Vertical), extending continuously between the top and the bottom of a cut.

The above-recommended temporary slope inclination is based on the conditions exposed in our explorations, and on what has been successful at other sites with similar soil conditions. It is possible that variations in soil and groundwater conditions will require modifications to the inclination at which temporary slopes can stand. Temporary cuts are those that will remain unsupported for a relatively short duration to allow for the construction of foundations, retaining walls, or utilities. Temporary cut slopes should be protected with plastic sheeting during wet weather. It is also important that surface runoff be directed away from the top of temporary slope cuts. Cut slopes should also be backfilled or retained as soon as possible to reduce the potential for instability. Please note that sand or loose soil can cave suddenly and without warning. Excavation, foundation, and utility contractors should be made especially aware of this potential danger. These recommendations may need to be modified if the area near the potential cuts has been disturbed in the past by utility installation, or if settlement-sensitive utilities are located nearby.

Water should not be allowed to flow uncontrolled over the top of any temporary or permanent slope. All permanently exposed slopes should be seeded with an appropriate species of vegetation to reduce erosion and improve the stability of the surficial layer of soil.

DRAINAGE CONSIDERATIONS

Footing drains should be used where: (1) crawl spaces or basements will be below a structure; (2) a slab is below the outside grade; or, (3) the outside grade does not slope downward from a building. Drains should also be placed at the base of all earth-retaining walls. These drains should be surrounded by at least 6 inches of 1-inch-minus, washed rock that is encircled with non-woven, geotextile filter fabric (Mirafi 140N, Supac 4NP, or similar material). At its highest point, a perforated pipe invert should be at least 6 inches below the bottom of a slab floor or the level of a crawl space. The discharge pipe for subsurface drains should be sloped for flow to the outlet point. Roof and surface water drains must not discharge into the foundation drain system. For the best long-term performance, perforated PVC pipe is recommended for all subsurface drains. Clean-outs should be provided for potential future flushing or cleaning of footing drains.

As a minimum, a vapor retarder, as defined in the ***Slabs-On-Grade*** section, should be provided in any crawl space area to limit the transmission of water vapor from the underlying soils. Crawl space grades are sometimes left near the elevation of the bottom of the footings. As a result, an outlet drain is recommended for all crawl spaces to prevent an accumulation of any water that may bypass the footing drains. Providing a few inches of free draining gravel underneath the vapor retarder is also prudent to limit the potential for seepage to build up on top of the vapor retarder.

Groundwater was observed during our field work. If seepage is encountered in an excavation, it should be drained from the site by directing it through drainage ditches, perforated pipe, or French drains, or by pumping it from sumps interconnected by shallow connector trenches at the bottom of the excavation.

The excavation and site should be graded so that surface water is directed off the site and away from the tops of slopes. Water should not be allowed to stand in any area where foundations, slabs, or pavements are to be constructed. Final site grading in areas adjacent to buildings should slope away at least one to 2 percent, except where the area is paved. Surface drains should be provided where necessary to prevent ponding of water behind foundation or retaining walls. A discussion of grading and drainage related to pervious surfaces near walls and structures is contained in the **Foundation and Retaining Walls** section.

GENERAL EARTHWORK AND STRUCTURAL FILL

All building and pavement areas should be stripped of surface vegetation, topsoil, organic soil, and other deleterious material. It is important that existing foundations be removed before site development. The stripped or removed materials should not be mixed with any materials to be used as structural fill, but they could be used in non-structural areas, such as landscape beds.

Structural fill is defined as any fill, including utility backfill, placed under, or close to, a building, or in other areas where the underlying soil needs to support loads. All structural fill should be placed in horizontal lifts with a moisture content at, or near, the optimum moisture content. The optimum moisture content is that moisture content that results in the greatest compacted dry density. The moisture content of fill is very important and must be closely controlled during the filling and compaction process.

The allowable thickness of the fill lift will depend on the material type selected, the compaction equipment used, and the number of passes made to compact the lift. The loose lift thickness should not exceed 12 inches, but should be thinner if small, hand-operated compactors are used. We recommend testing structural fill as it is placed. If the fill is not sufficiently compacted, it should be recompacted before another lift is placed. This eliminates the need to remove the fill to achieve the required compaction. The following table presents recommended levels of relative compaction for compacted fill:

LOCATION OF FILL PLACEMENT	MINIMUM RELATIVE COMPACTION
Beneath footings, slabs or walkways	95%
Filled slopes and behind retaining walls	90%

Where: Minimum Relative Compaction is the ratio, expressed in percentages, of the compacted dry density to the maximum dry density, as determined in accordance with ASTM Test Designation D 1557-91 (Modified Proctor).

Structural fill that will be placed in wet weather should consist of a coarse, granular soil with a silt or clay content of no more than 5 percent. The percentage of particles passing the No. 200 sieve should be measured from that portion of soil passing the three-quarter-inch sieve.

LIMITATIONS

The conclusions and recommendations contained in this report are based on site conditions as they existed at the time of our exploration and assume that the soil and groundwater conditions encountered in the explorations are representative of subsurface conditions on the site. If the subsurface conditions encountered during construction are significantly different from those observed in our explorations, we should be advised at once so that we can review these conditions and reconsider our recommendations where necessary. Unanticipated conditions are commonly encountered on construction sites and cannot be fully anticipated by merely taking samples in explorations. Subsurface conditions can also vary between exploration locations. Such unexpected conditions frequently require making additional expenditures to attain a properly constructed project. It is recommended that the owner consider providing a contingency fund to accommodate such potential extra costs and risks. This is a standard recommendation for all projects.

This report has been prepared for the exclusive use of the Headrick Family and their representatives, for specific application to this project and site. Our conclusions and recommendations are professional opinions derived in accordance with our understanding of current local standards of practice, and within the scope of our services. No warranty is expressed or implied. The scope of our services does not include services related to construction safety precautions, and our recommendations are not intended to direct the contractor's methods, techniques, sequences, or procedures, except as specifically described in our report for consideration in design. Our services also do not include assessing or minimizing the potential for biological hazards, such as mold, bacteria, mildew and fungi in either the existing or proposed site development.

ADDITIONAL SERVICES

Geotech Consultants, Inc. should be retained to provide geotechnical consultation, testing, and observation services during construction. This is to confirm that subsurface conditions are consistent with those indicated by our exploration, to evaluate whether earthwork and foundation construction activities comply with the general intent of the recommendations presented in this report, and to provide suggestions for design changes in the event subsurface conditions differ from those anticipated prior to the start of construction. However, our work would not include the supervision or direction of the actual work of the contractor and its employees or agents. Also, job and site safety, and dimensional measurements, will be the responsibility of the contractor.

During the construction phase, we will provide geotechnical observation and testing services when requested by you or your representatives. Please be aware that we can only document site work we actually observe. It is still the responsibility of your contractor or on-site construction team to verify that our recommendations are being followed, whether we are present at the site or not.

The following plates are attached to complete this report:

Plate 1	Vicinity Map
Plate 2	Site Exploration Plan
Plates 3 - 4	Test Pit Logs
Plate 5	Test Hole Logs

We appreciate the opportunity to be of service on this project. Please contact us if you have any questions, or if we can be of further assistance.

Respectfully submitted,
GEOTECH CONSULTANTS, INC.

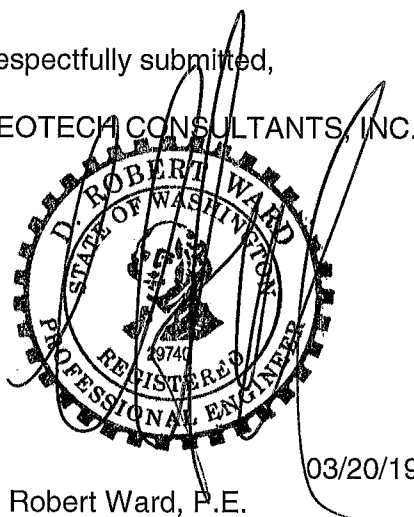

03/20/19

D. Robert Ward, P.E.
Principal

DRW:kg

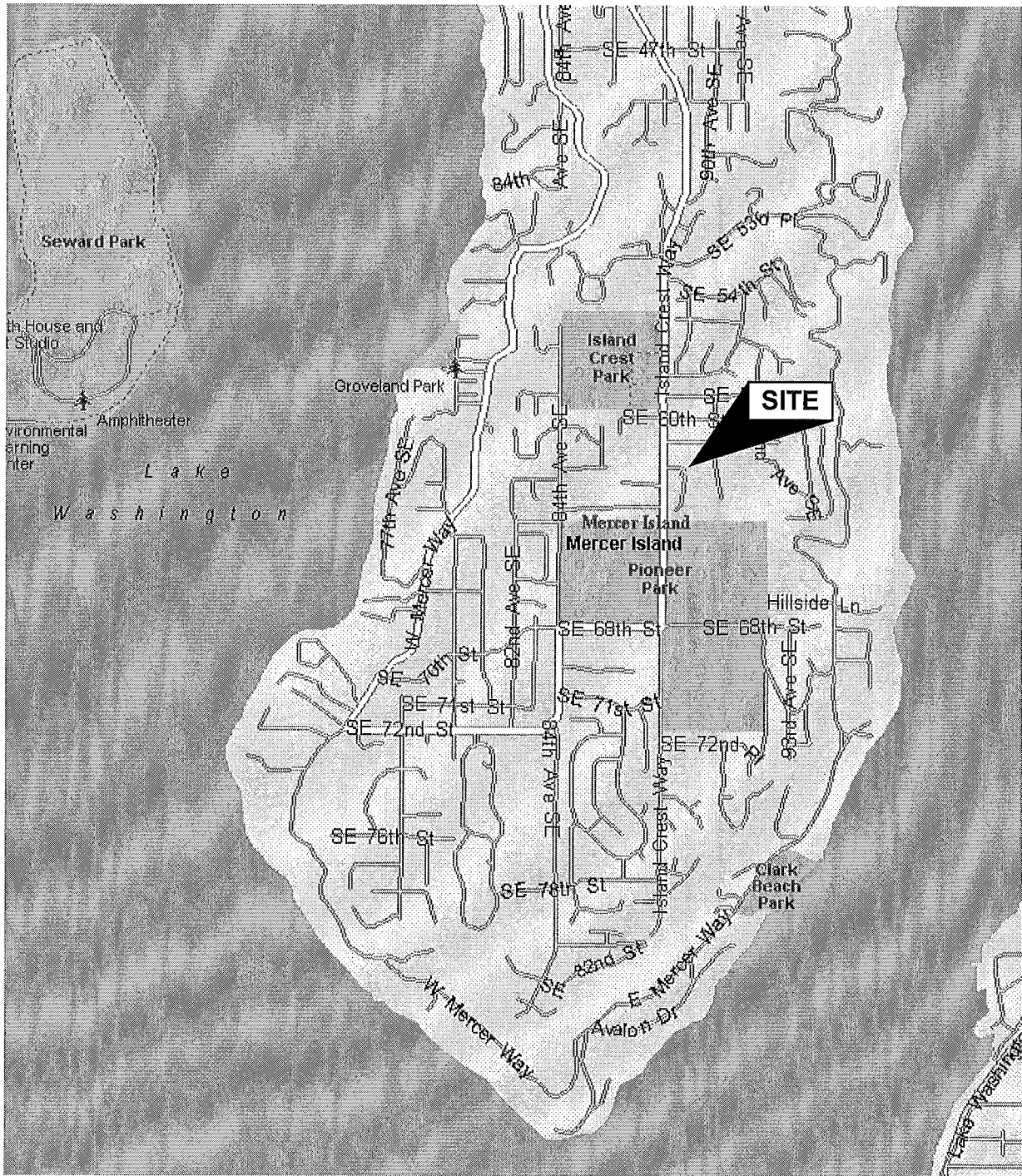
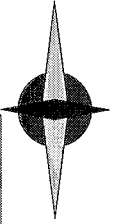

(Source: Microsoft MapPoint, 2013)



GEOTECH
CONSULTANTS, INC.



VICINITY MAP

8822 Southeast 62nd Street
Mercer Island, Washington

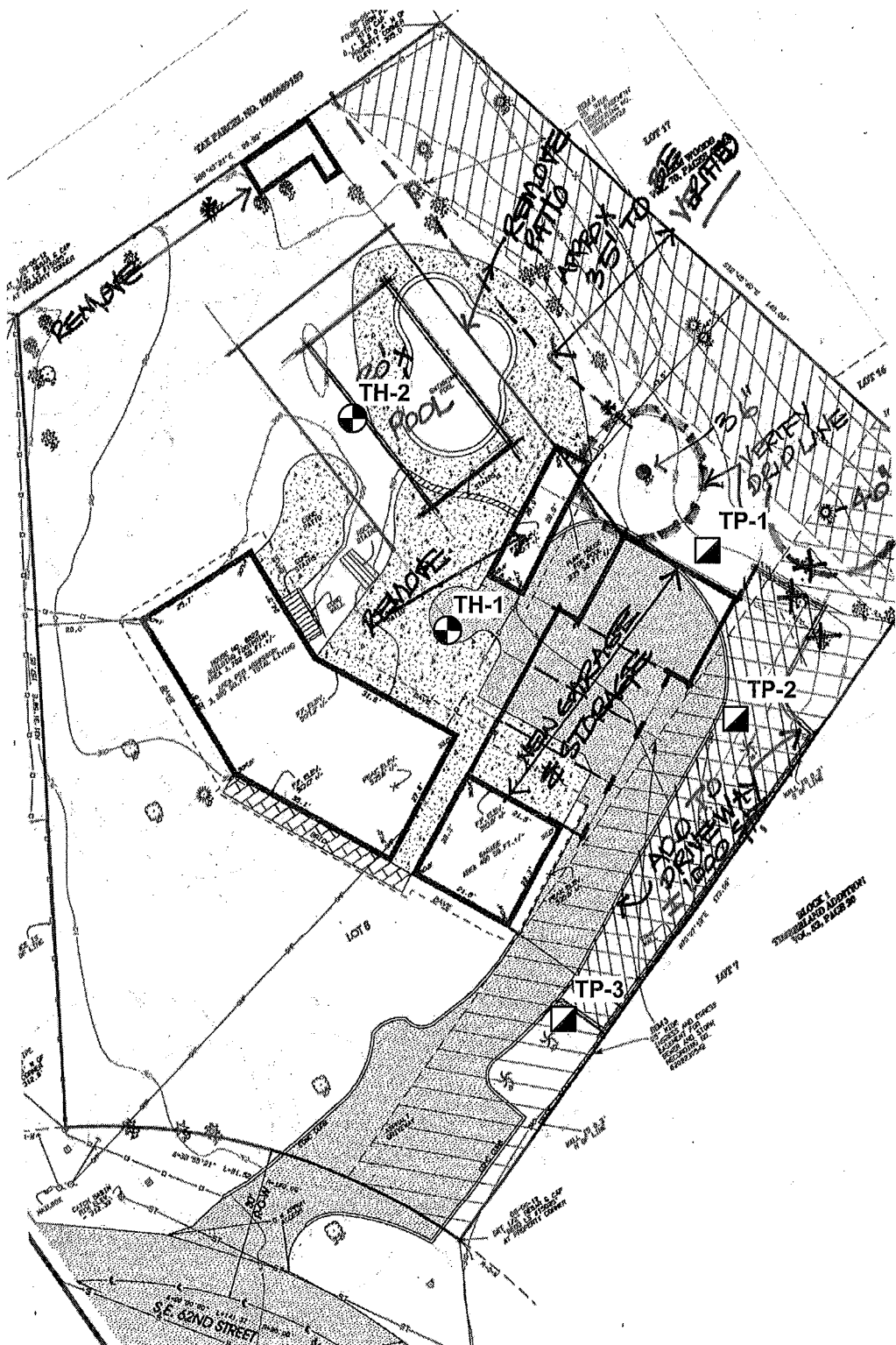
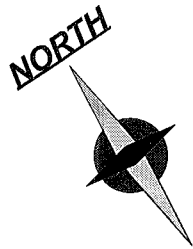
Job No: 19086	Date: Mar. 2019	Plate: 1
------------------	--------------------	-------------



Legend:

-  Test Pit Location
-  Test Hole Location



GEOTECH
CONSULTANTS, INC.

SITE EXPLORATION PLAN

8822 Southeast 62nd Street
Mercer Island, Washington

Job No: 19086	Date: Mar. 2019	No Scale	Plate: 2
------------------	--------------------	----------	-------------

Depth (ft.)
Moisture
Content (%)
Water
Table
USCS

TEST PIT 1

Description

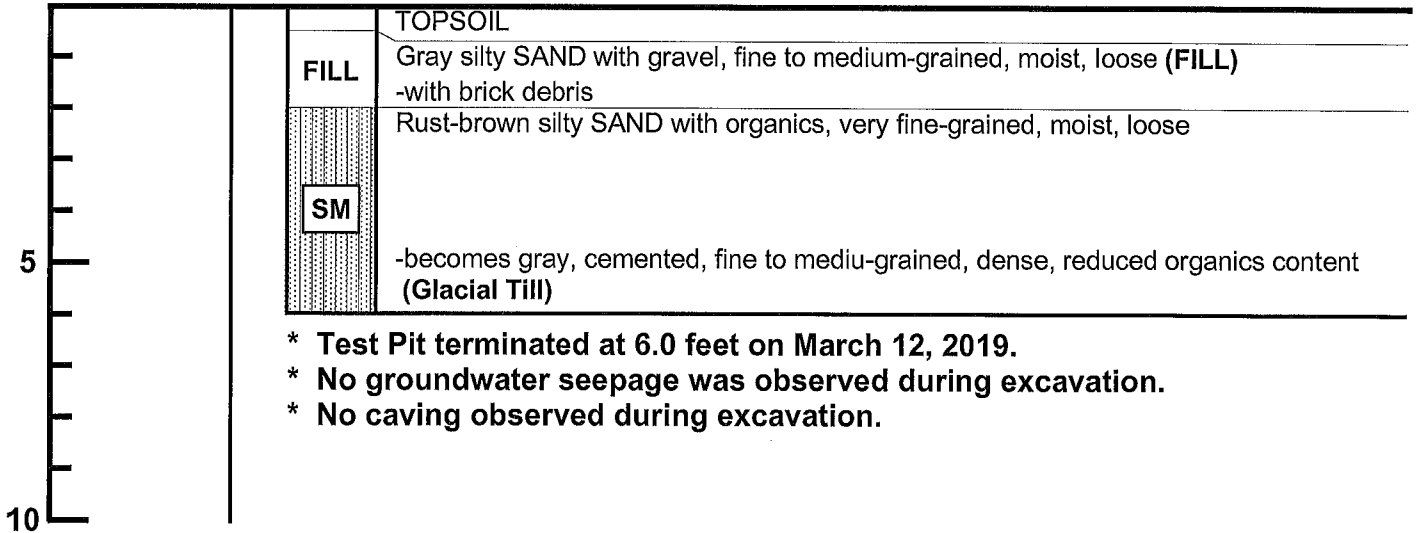

TEST PIT 2

Depth (ft.)
Moisture
Content (%)
Water
Table
USCS

Description

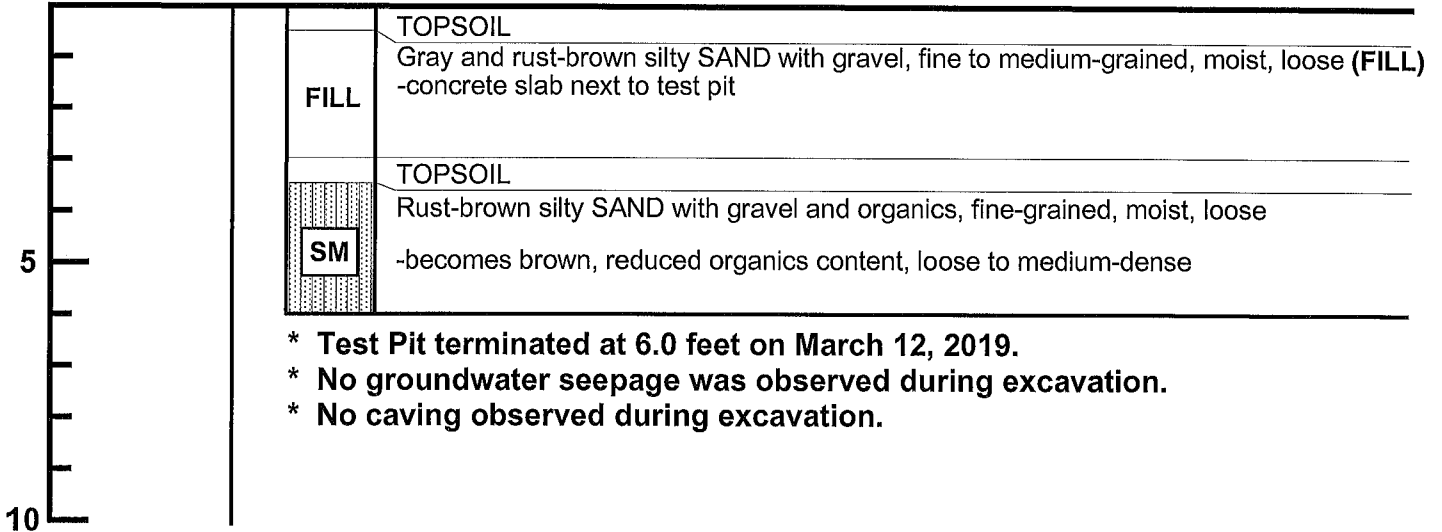

TEST PIT LOG

8822 Southeast 62nd Street
Mercer Island, Washington

Job 19086	Date: Mar. 2019	Logged by: ASM	Plate: 3
---------------------	---------------------------	--------------------------	--------------------

Depth (ft.)
Moisture
Content (%)
Water
Table
USCS

TEST PIT 3

Description

	FILL	Dark-brown silty SAND with abundant organics, fine to medium-grained, moist, loose (FILL)
	TOPSOIL	
	SM	Rust-brown silty SAND with gravel, fine-grained, moist, loose -becomes gray, cemented, dense (Glacial Till)

- * Test Pit terminated at 5.8 feet on March 12, 2019.
- * Perched groundwater seepage was observed from 3.5 to 4 feet during excavation.
- * No caving observed during excavation.



TEST PIT LOG
8822 Southeast 62nd Street
Mercer Island, Washington

Job 19086	Date: Mar. 2019	Logged by: ASM	Plate: 4
---------------------	---------------------------	--------------------------	--------------------

TEST HOLE 1

Depth (feet)	Soil Description
0.0 – 0.5	Topsoil
0.5 – 4.0	Rust-brown silty SAND with gravel and organics, fine to medium-grained, moist, loose [SM] - at 3.5 feet; becomes gray-brown, cemented, dense, reduced organics content (Glacial Till)

Test Hole was terminated at 4.0 feet on March 12, 2018.
No groundwater seepage was encountered in the test hole.

TEST HOLE 2

Depth (feet)	Soil Description
0.0 – 0.5	Topsoil
0.5 – 4.0	Rust-brown silty SAND with gravel, fine to medium-grained, moist, loose [SM] - at 1.5 feet; becomes gray-brown, cemented, dense (Glacial Till)

Test Hole was terminated at 2.0 feet on March 12, 2018.
No groundwater seepage was encountered in the test hole.

***NOTE** – Letters in brackets [] denote the USCS soil classification.



GEOTECH
CONSULTANTS, INC.

TEST HOLE LOGS

8822 Southeast 62nd Street
Mercer Island, Washington

Job No: 19086	Date: Mar. 2019	Plate: 5
------------------	--------------------	-------------

Appendix D – Reconnaissance Report

September 21, 2018

Greg and Jennifer Headrick
8822 SE 62nd St
Mercer Island, WA 98040

RE: Reconnaissance Report for King County Parcel No. 8650500040, Located at 8822 SE 62nd Street, in the City of Mercer Island

Introduction

Wetland Resources, Inc. (WRI) performed a critical areas reconnaissance on September 20, 2018, to identify regulated wetlands and watercourses on and in the vicinity of the 0.63-acre parcel located at 8822 SE 62nd Street. Access is from the west via SE 62nd Street. The subject property is located within the Cedar/Sammamish Watershed, in the Mercer Island subbasin.

The subject property is a relatively level lot that slopes to a shallow ravine in the eastern portion of the property. The level portion of the site is developed with a single-family residence and appurtenant structures/uses, including access/parking, storage sheds, ornamental landscaping, lawngrass, and a pool. A seasonal stream channel was identified along the eastern property line, as depicted in Figure 1 below. No other critical areas were observed on or in the vicinity of the subject property.

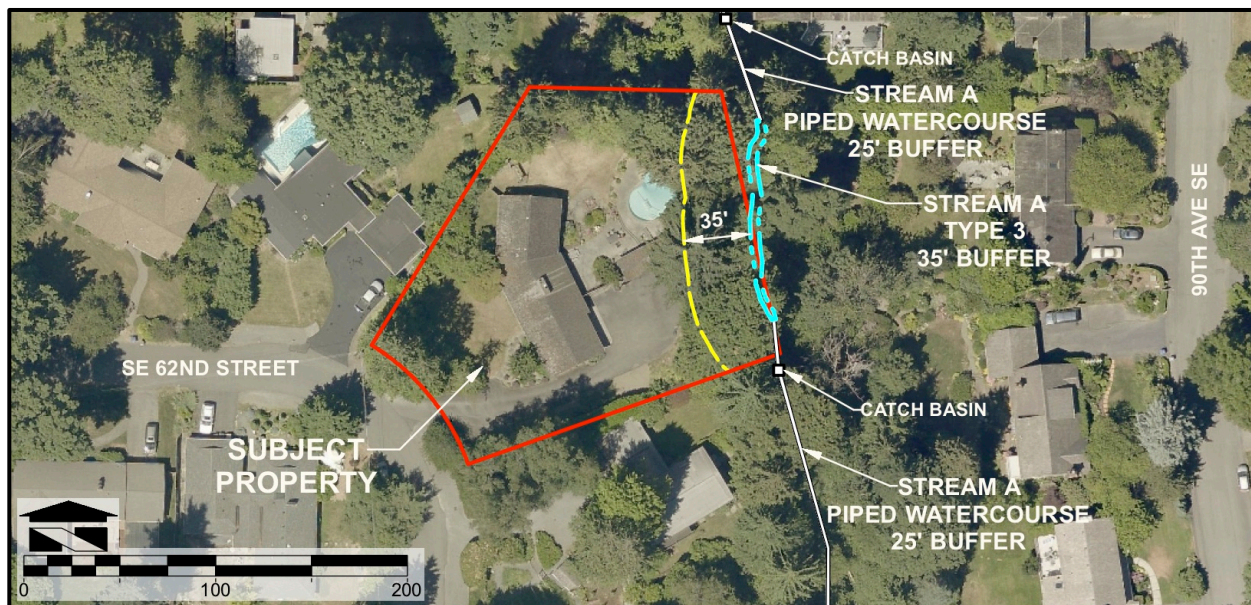

Figure 1: Aerial Overview of Subject Property

Critical Areas Findings

The City of Mercer Island Development Services Group relies on data compiled in the City of Mercer Island GIS Portal to approximate critical areas presence and locate stormwater features (among many other things). This resource was used by WRI staff prior to the site investigation, to determine potential critical areas on and in the vicinity of the subject property. This resource depicts two Type 3 watercourses within the boundaries of the subject property; Stream A, which flows through the aforementioned ravine along the east property line, and a tributary to Stream A, which is shown passing through maintained lawn, the primary residence, and impervious surfaces in the northern portion of the site. Based on the developed condition of the site, it is highly unlikely that a Type 3 watercourse flows through the property. Special care was taken during the site inspection to confirm or deny the presence of the mapped tributary.

Stream A is the only critical area feature that was observed within the subject property. The mapped tributary to Stream A was not observed. No evidence of a surface channel is present in or around the mapped location of the tributary to Stream A. The mapped tributary to Stream A is a map error that should be corrected by City staff based on WRI findings.

Critical Area Name	Critical Area Type	Standard Buffer Width
Stream A	Piped or Restored	25 feet
Stream A	Type 3	35 feet

Table 1: Critical Areas Summary

The on-site boundaries of Stream A were estimated in the field, and refined in the office using fine-scale elevation contours derived from the King County 3x3 Digital Elevation Model (DEM). The stream enters the site near the northeast property corner, where flows discharge from a large-diameter culvert. The stream flows south along the east property line within an approximately three-foot-wide surface channel. The surface channel then flows into another culvert, located in approximately the southeast corner of the property. Bed material within the open channel consists of small to medium cobble, and indicates that stream velocity is relatively high during large rain events. The channel was dry during the September site visit, which supports the Type 3 classification made by the City. Type 3 watercourses require 35-foot protective buffers in the city of Mercer Island. Piped watercourses require 25-foot protective buffers.

The protective buffer associated with Stream A appears to terminate in the vicinity of existing development (in the level portion of the site). It is possible that existing development encroaches slightly into the buffer associated with Stream A. Previously developed areas within 35 feet of Stream A are considered a legally existing non-conforming use, because they were constructed prior to the adoption of 35-foot protective buffers. Generally, nonconforming uses can be maintained and repaired. Changes in use may also be allowed by the DSG, provided that they do not increase the nonconformance.

Use of This Report

This report is supplied to Greg and Jennifer Headrick as a means of determining the presence of on-site and adjacent critical areas as required by the City of Mercer Island. This report is based largely on readily observable conditions and, to a lesser extent, on readily ascertainable conditions. No attempt has been made to determine hidden or concealed conditions.

The laws applicable to critical areas are subject to varying interpretations and may be changed at any time by the courts or legislative bodies. This report is intended to provide information deemed relevant

in the applicant's attempt to comply with the laws now in effect.

This report conforms to the standard of care employed by ecologists. No other representation or warranty is made concerning the work or this report and any implied representation or warranty is disclaimed.

Wetland Resources, Inc.

A handwritten signature in black ink, appearing to read "Niels Pedersen", with a long, sweeping horizontal flourish at the end.

Niels Pedersen
Senior Ecologist





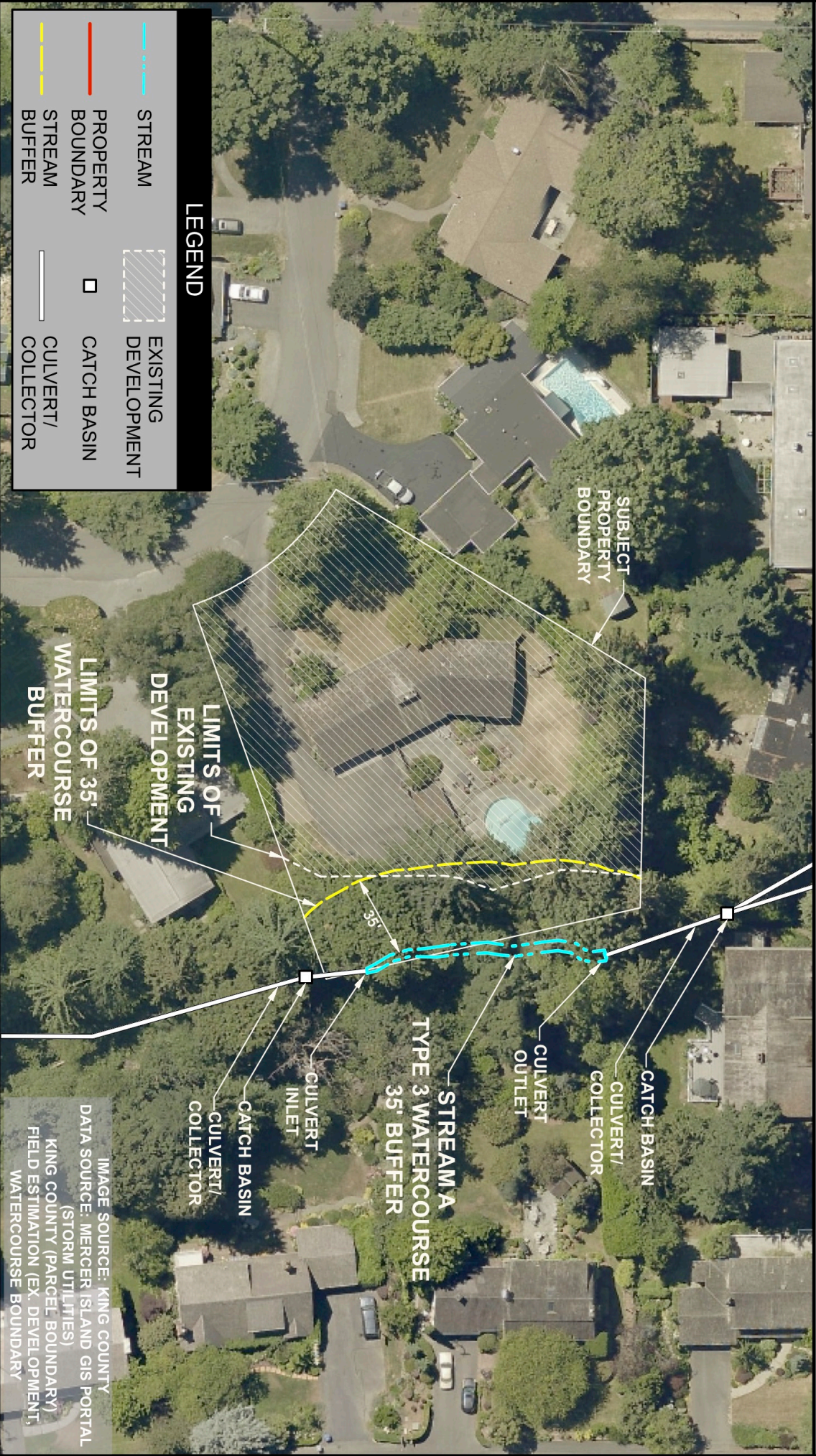

Enclosures:
Critical Areas Reconnaissance Map (Sheet 1/1)

(this page intentionally left blank)

CRITICAL AREAS RECONNAISSANCE MAP

HEADRICK - 8822 SE 62ND ST



LEGEND			
	STREAM		EXISTING DEVELOPMENT
	PROPERTY BOUNDARY		CATCH BASIN
	STREAM BUFFER		CULVERT/ COLLECTOR

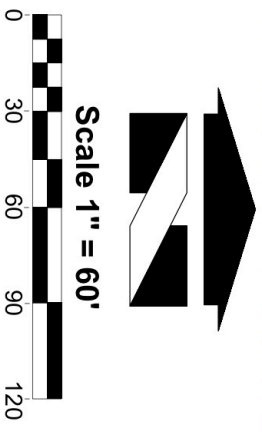

PLEASE NOTE: THIS MAP IS **APPROXIMATE** FOR PLANNING AND DISCUSSION PURPOSES ONLY. THIS DOES NOT REPRESENT A DELINEATION OR SURVEY. ALL WATERCOURSES, BUFFERS, AND PROPERTY LINE LOCATIONS ARE **APPROXIMATE**. THE LOCATIONS SHOWN ON THIS MAP SHOULD **NOT** BE USED TO CREATE A FORMAL SITE LAYOUT.

Wetland Resources, Inc.
 Consulting / Mitigation / Restoration / Habitat Creation / Permit Assistance
 9505 19th Avenue S.E. Suite 106 Everett, Washington 98208
 Phone: (425) 337-3174
 Fax: (425) 337-3045
 Email: mailbox@wetlandresources.com

Critical Areas Reconnaissance Map
Headrick - 8822 SE 62nd St
 City of Mercer Island

Greg & Jennifer Headrick Project Number: 18303
 8822 SE 62nd St Drawn by: NP
 Mercer Island, WA 98040 Sheet 1/1
 09/21/2018

IMAGE SOURCE: KING COUNTY
 DATA SOURCE: MERCER ISLAND GIS PORTAL
 (STORM UTILITIES)
 KING COUNTY (PARCEL BOUNDARY)
 FIELD ESTIMATION (EX. DEVELOPMENT,
 WATERCOURSE BOUNDARY)

(this page intentionally left blank)

September 21, 2018

Greg and Jennifer Headrick
8822 SE 62nd St
Mercer Island, WA 98040

RE: Reconnaissance Report for King County Parcel No. 8650500040, Located at 8822 SE 62nd Street, in the City of Mercer Island

Introduction

Wetland Resources, Inc. (WRI) performed a critical areas reconnaissance on September 20, 2018, to identify regulated wetlands and watercourses on and in the vicinity of the 0.63-acre parcel located at 8822 SE 62nd Street. Access is from the west via SE 62nd Street. The subject property is located within the Cedar/Sammamish Watershed, in the Mercer Island subbasin.

The subject property is a relatively level lot that slopes to a shallow ravine in the eastern portion of the property. The level portion of the site is developed with a single-family residence and appurtenant structures/uses, including access/parking, storage sheds, ornamental landscaping, lawngrass, and a pool. A seasonal stream channel was identified along the eastern property line, as depicted in Figure 1 below. No other critical areas were observed on or in the vicinity of the subject property.

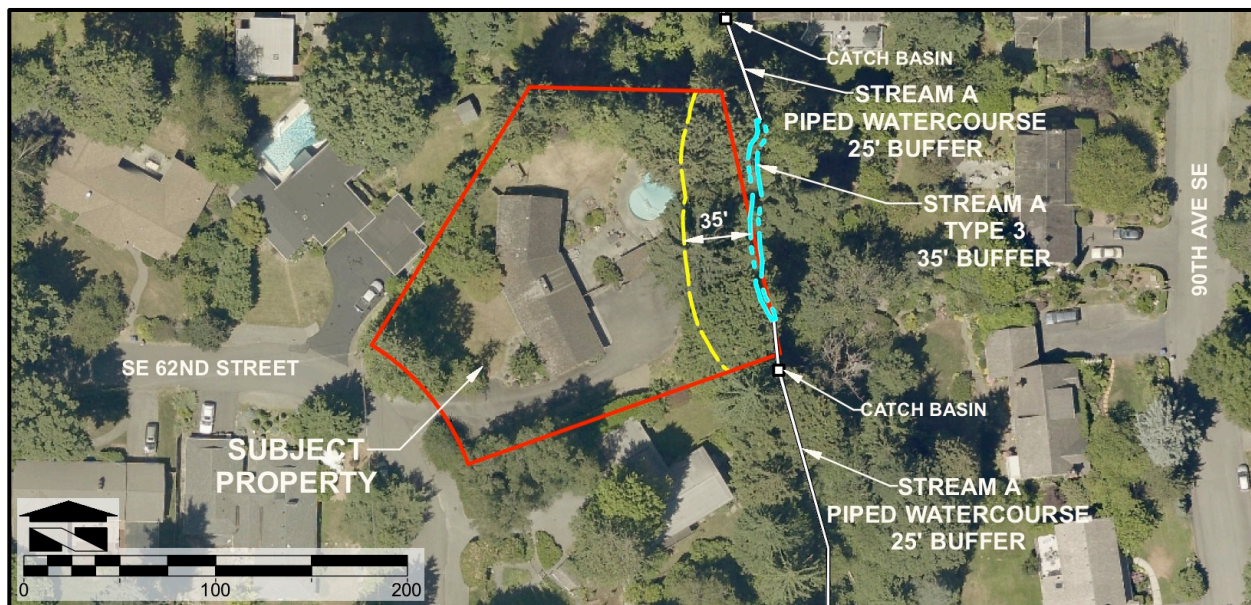

Figure 1: Aerial Overview of Subject Property

Critical Areas Findings

The City of Mercer Island Development Services Group relies on data compiled in the City of Mercer Island GIS Portal to approximate critical areas presence and locate stormwater features (among many other things). This resource was used by WRI staff prior to the site investigation, to determine potential critical areas on and in the vicinity of the subject property. This resource depicts two Type 3 watercourses within the boundaries of the subject property; Stream A, which flows through the aforementioned ravine along the east property line, and a tributary to Stream A, which is shown passing through maintained lawn, the primary residence, and impervious surfaces in the northern portion of the site. Based on the developed condition of the site, it is highly unlikely that a Type 3 watercourse flows through the property. Special care was taken during the site inspection to confirm or deny the presence of the mapped tributary.

Stream A is the only critical area feature that was observed within the subject property. The mapped tributary to Stream A was not observed. No evidence of a surface channel is present in or around the mapped location of the tributary to Stream A. The mapped tributary to Stream A is a map error that should be corrected by City staff based on WRI findings.

Critical Area Name	Critical Area Type	Standard Buffer Width
Stream A	Piped or Restored	25 feet
Stream A	Type 3	35 feet

Table 1: Critical Areas Summary

The on-site boundaries of Stream A were estimated in the field, and refined in the office using fine-scale elevation contours derived from the King County 3x3 Digital Elevation Model (DEM). The stream enters the site near the northeast property corner, where flows discharge from a large-diameter culvert. The stream flows south along the east property line within an approximately three-foot-wide surface channel. The surface channel then flows into another culvert, located in approximately the southeast corner of the property. Bed material within the open channel consists of small to medium cobble, and indicates that stream velocity is relatively high during large rain events. The channel was dry during the September site visit, which supports the Type 3 classification made by the City. Type 3 watercourses require 35-foot protective buffers in the city of Mercer Island. Piped watercourses require 25-foot protective buffers.

The protective buffer associated with Stream A appears to terminate in the vicinity of existing development (in the level portion of the site). It is possible that existing development encroaches slightly into the buffer associated with Stream A. Previously developed areas within 35 feet of Stream A are considered a legally existing non-conforming use, because they were constructed prior to the adoption of 35-foot protective buffers. Generally, nonconforming uses can be maintained and repaired. Changes in use may also be allowed by the DSG, provided that they do not increase the nonconformance.

Use of This Report

This report is supplied to Greg and Jennifer Headrick as a means of determining the presence of on-site and adjacent critical areas as required by the City of Mercer Island. This report is based largely on readily observable conditions and, to a lesser extent, on readily ascertainable conditions. No attempt has been made to determine hidden or concealed conditions.

The laws applicable to critical areas are subject to varying interpretations and may be changed at any time by the courts or legislative bodies. This report is intended to provide information deemed relevant

in the applicant's attempt to comply with the laws now in effect.

This report conforms to the standard of care employed by ecologists. No other representation or warranty is made concerning the work or this report and any implied representation or warranty is disclaimed.

Wetland Resources, Inc.

A handwritten signature in black ink, appearing to read "Niels Pedersen", with a long, sweeping horizontal flourish at the end.

Niels Pedersen
Senior Ecologist

Enclosures:
Critical Areas Reconnaissance Map (Sheet 1/1)

(this page intentionally left blank)

CRITICAL AREAS RECONNAISSANCE MAP

HEADRICK - 8822 SE 62ND ST

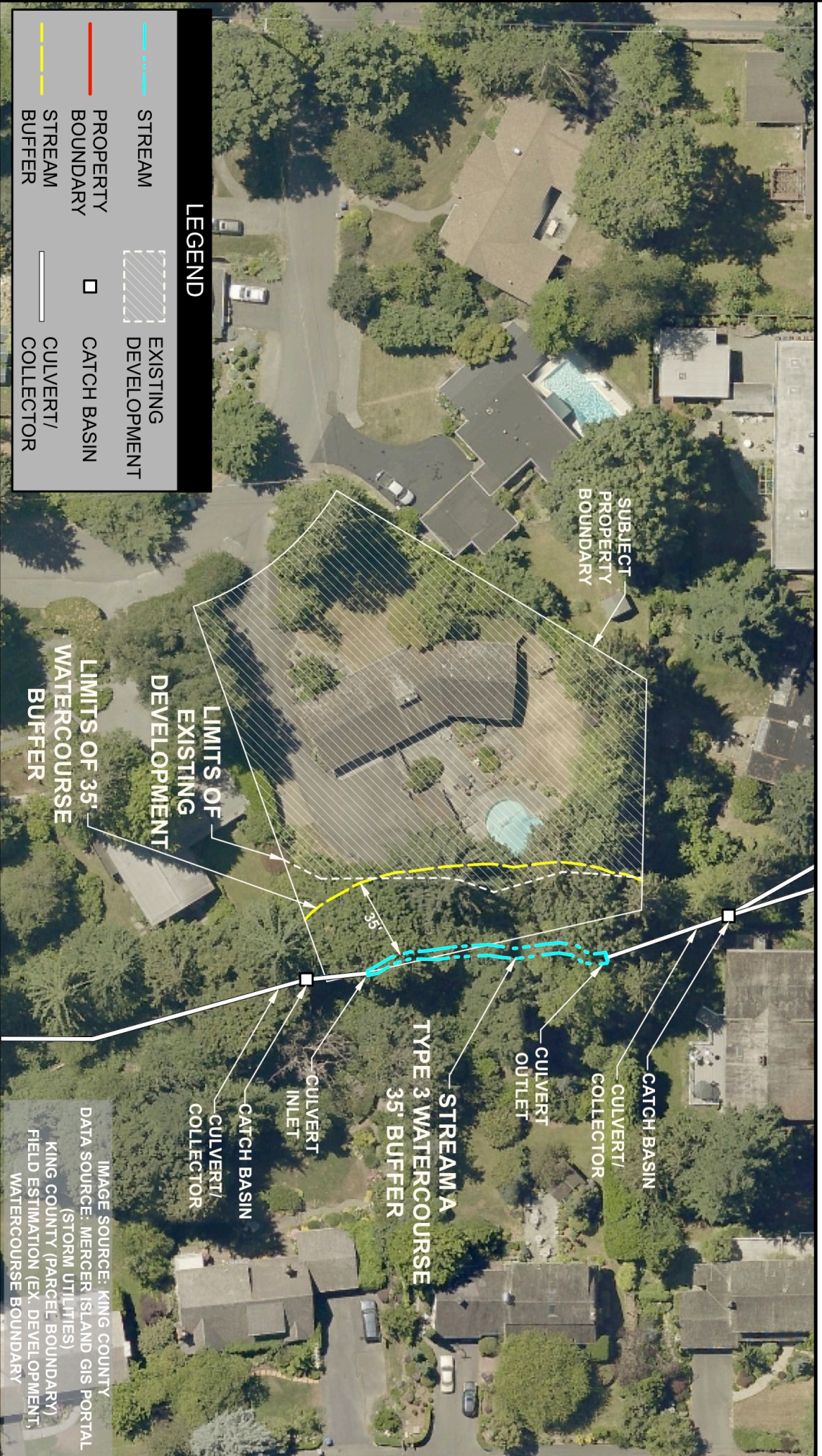

LEGEND			
	STREAM		EXISTING DEVELOPMENT
	PROPERTY BOUNDARY		CATCH BASIN
	STREAM BUFFER		CULVERT/ COLLECTOR

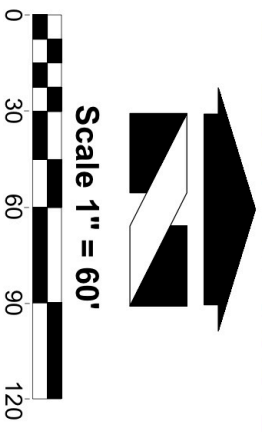

PLEASE NOTE: THIS MAP IS **APPROXIMATE** FOR PLANNING AND DISCUSSION PURPOSES ONLY. THIS DOES NOT REPRESENT A DELINEATION OR SURVEY. ALL WATERCOURSES, BUFFERS, AND PROPERTY LINE LOCATIONS ARE **APPROXIMATE**. THE LOCATIONS SHOWN ON THIS MAP SHOULD **NOT** BE USED TO CREATE A FORMAL SITE LAYOUT.

Wetland Resources, Inc.
 Consulting / Mitigation / Restoration / Habitat Creation / Permit Assistance
 9505 19th Avenue S.E. Suite 108 Everett, Washington 98208
 Phone: (425) 337-3174
 Fax: (425) 337-3045
 Email: mailbox@wetlandresources.com

Critical Areas Reconnaissance Map
Headrick - 8822 SE 62nd St
 City of Mercer Island
 Greg & Jennifer Headrick Project Number: 18303
 8822 SE 62nd St Drawn by: NP
 Mercer Island, WA 98040 Sheet 1/1
 09/21/2018

IMAGE SOURCE: KING COUNTY
 DATA SOURCE: MERCER ISLAND GIS PORTAL
 (STORM UTILITIES)
 KING COUNTY (PARCEL BOUNDARY)
 FIELD ESTIMATION (EX. DEVELOPMENT,
 WATERCOURSE BOUNDARY)